

EJ-XPRO

VACUUM PUMP
WITH EMBEDDED
ELECTRONICS



A unique solution with embedded smart features
and a simple, robust and intuitive design
for uncompromising operation



EJ-XPRO

A unique solution, configurable...

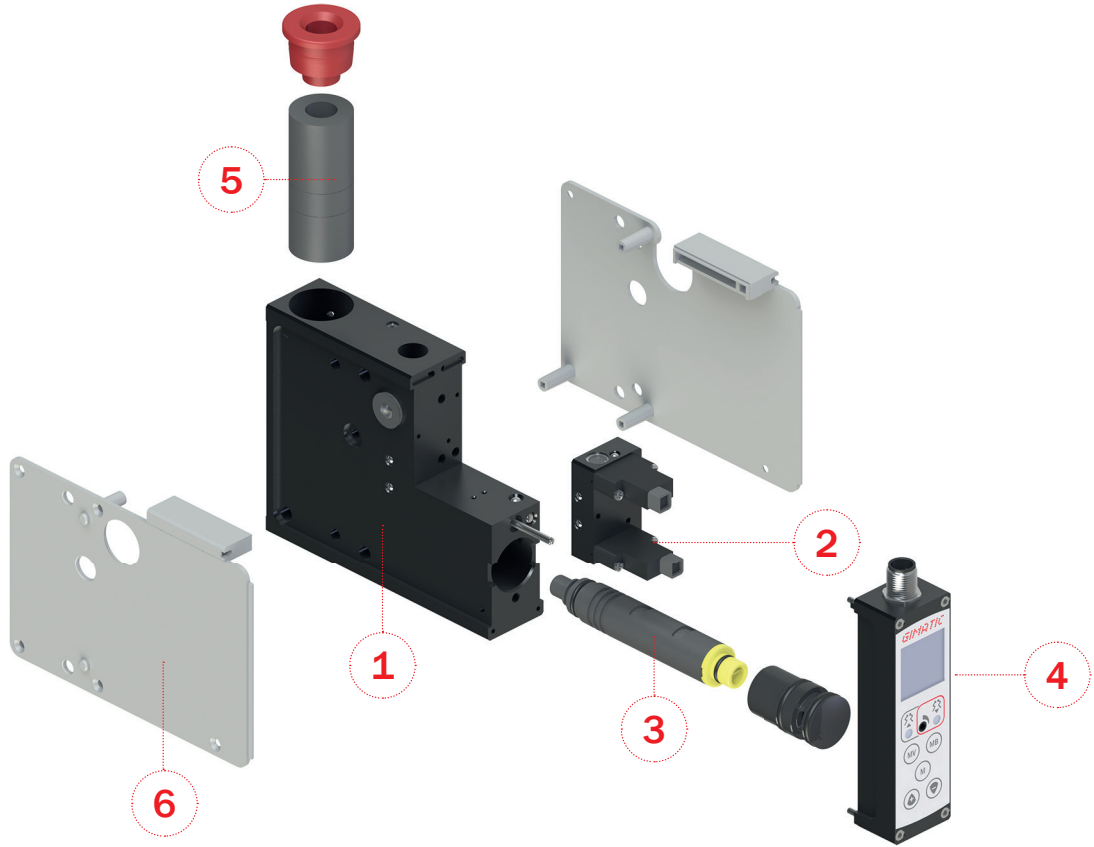

Main components

1 Lightweight and robust monolithic body in oxidated aluminum material.

2 Reconfigurable and independent valves subsystem with high flow and fast response. Electrovalves can easily be accessed and replaced by the user.

3 Integrated 2 stages large size ejector. The simple and modular design of the pump makes easy for the user to access the ejector for maintenance and cleaning operations. It is possible to choose the best ejector for a specific application by selecting one of the following ejector types: high flow (HF), high vacuum (HV) or low supply pressure (LP).

4 Electrical interface subsystem made of a LCD TFT screen with an intuitive graphics and a keyboard, embedded circuit board with advanced functions and a M12 8 pins male connector for power supply and I/O signals connection.

5 Integrated silenced exhaust.

6 Plastic components made of a high-quality Nylon material glass fiber reinforced.

...and modular

The **EJ-XPRO** pump series can be used in stand-alone applications or connected in series up to 4 units in total by simply acting on the special embedded grub screw. This also makes easy the replacement of a unit in case of need. For a system composed of multiple units in series, it's possible to supply pressurized air by a single input channel and eventually convey the exhausts by using a special exhaust adaptor.



- > Connection for manifold mount, maximum 4 units.
- > Flexible installation.
- > Possibility to mount and remove the single units.





Main features

Innovative vacuum pumps with fully integrated smart controls

- > Quality material.
- > Easy to install.
- > Powerful and reliable.
- > Simplified maintenance.
- > Compact dimensions.
- > Configurations complete with solenoid valves for vacuum generation (NC/NO) and blow-off.
- > Maximum vacuum level up to -95 kPa.
- > Suction flow rate up to 150 NI/min.
- > Integrated blow-off with manual adjustment.



Electrical installation

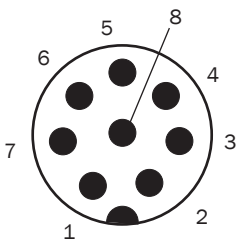

Pin N°	Name	Description	Colour
1	GRIP-ON	Part gripped digital output	White
2	24V	+24 Vdc	Brown
3	SENS	Analogue output proportional to vacuum switch signal	Green
4	VAC	Vacuum valve control digital input	Yellow
5	ES-ON	Energy saving active status digital output	Grey
6	BLW	Blow-off valve control digital input	Pink
7	GND	GND	Blue
8	ERROR	Pump error digital output	Red

Intuitive and comprehensive interface

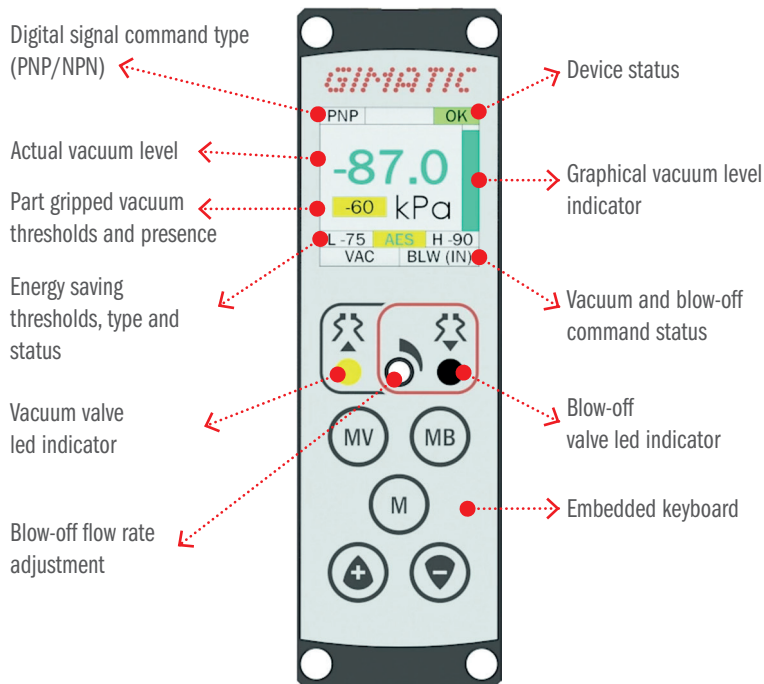

- > Simple and intuitive graphical interface for managing the pump functions.
- > Integrated vacuum switch with analogue and digital output.
- > Physical buttons for menu management.
- > Compact and stackable vacuum pumps.
- > Easy replacement of vacuum cartridge generator.

Large color display to read the pump status

PART PRESENT

Specific display area is colored in yellow when the object is handled.

BLOW-OFF

Two types of blow-off selectable from the menu:

- **INPUT:** The blow-off is electrically activated by pin 6
- **AUTO:** At each automatic cycle, the blow-off flow will be performed for the duration set in the menu.

For both models, the blow-off air flow rate is mechanically adjustable.

ENERGY SAVING

Allows to save up to 90-95% of compressed air at each cycle.

AUTOMATIC ENERGY SAVING

Automatically identifies the optimal vacuum thresholds levels at each cycle regardless of the type of material.

AUTO EXCLUDE

In case of significant leakage in the system, this function disables the ES to protect the valves and their lifetime.



Embedded features

Maintenance and replacement of ejector

The mechanical design of **EJ-XPRO** pump series allows for an easy access to the vacuum ejector's installation area. By simply removing the frontal display subsystem, the user can directly extract the ejector for easy replacement or cleaning operations. It's also possible to change the ejector type choosing between 3 different models: **HF** (optimizing the vacuum level), **HV** (maximizing the vacuum grade) and **LP** (optimizing the consumption air flow by operating the pump with a low pressure supply level).



Energy saving (ES)

If the function is enabled with the corresponding menu item, and provided there are no leakages, the energy saving feature allows considerable savings of compressed air by switching off vacuum generation and retaining the vacuum in the circuit (this must not be considered as a safety system in the event of compressed air/electricity supply interruption). The vacuum is retained by means of a valve on the cartridge and the blow-off function must therefore be activated in order to release the handled object.

The **ES low** and **ES high** thresholds must be set through the menu.

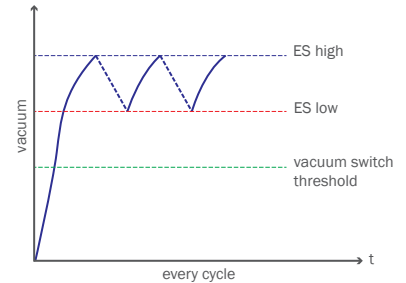

Automatic energy saving (AES)

If **ENERGY SAVING** is enabled in the menu, the function **AES** is activated by setting the **ES low** and **ES high** values to -98 kPa and -99 kPa respectively. It allows the automatic setting of energy saving trigger thresholds for each cycle, based on the maximum vacuum level attainable on the material being handled.

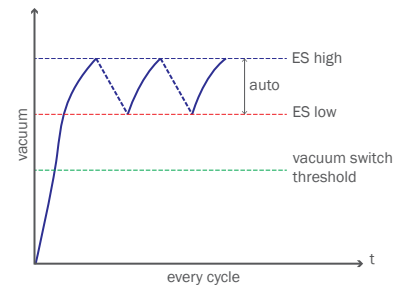

Auto exclude (AEX)

If the object being gripped is too porous, or if there are any leaks in the vacuum circuit to an extent that makes it impossible to use the **ENERGY SAVING** feature, the **AUTO EXCLUDE** function will be activated to create maximum vacuum.

In particular, if enabled with the corresponding menu item, the function intervenes by excluding the ES function in all those cases in which there is a high number of reactivations of the vacuum valve in a short time. This function also eliminates frequent activations, extending the life of the vacuum solenoid valve.

≥ 2 reactivations in 3 seconds: the pump is activated to provide continuous vacuum.

< 2 reactivations in 3 seconds: pump continues to run with ES.

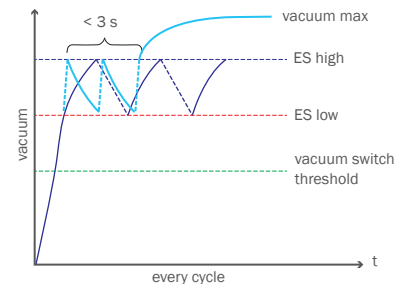

PWM modulation

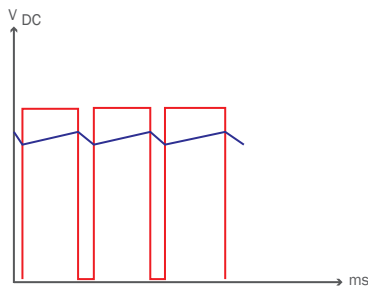

The **EJ-XPRO** circuit board integrates several advanced features such as a **PWM** to power supply the electro-valves. This allows for several benefits like:

- a fast response time of the system, by providing full electrical power when valves are initially activated
- optimized power consumption and reduced heat generation
- extended lifetime of the components

Automatic blow-off

The **EJ-XPRO** pump series offers an integrated blow-off channel for an easy and quick release of the part handled once the vacuum is removed. The blow-off type can be configured manually by navigating the digital menu of product and selecting a blow-off from input digital signal or an automatic blow-off. With a blow-off from input signal, the blow-off is triggered by an external digital signal provided at a specific pin of the M12 connector. With an automatic blow-off selection, the **EJ-XPRO** pump activates the blow-off autonomously after interruption of the vacuum generation signal. In this case, it's also possible to define the duration of the blow-off by setting a dedicated parameter of the digital menu.

Enhanced blow-off

The front panel of the **EJ-XPRO** pump series hosts a slotted head screw by which the user can manually adjust the intensity (flow-rate) of the blow-off.

> Automatic blow-off

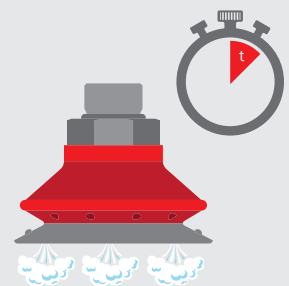

> Enhanced blow-off





Industries



Automotive

- > Molding lines
- > Pre-welded body assembly
- > Vehicle assembly lines (e.g. windshield)



VG.MB



VG.LB53

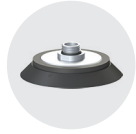

VG.CF



Sheet metal

- > Loading / unloading and tending of presses
- > Punching
- > Bending machines



VG.MF



VG.CF



VG.U42

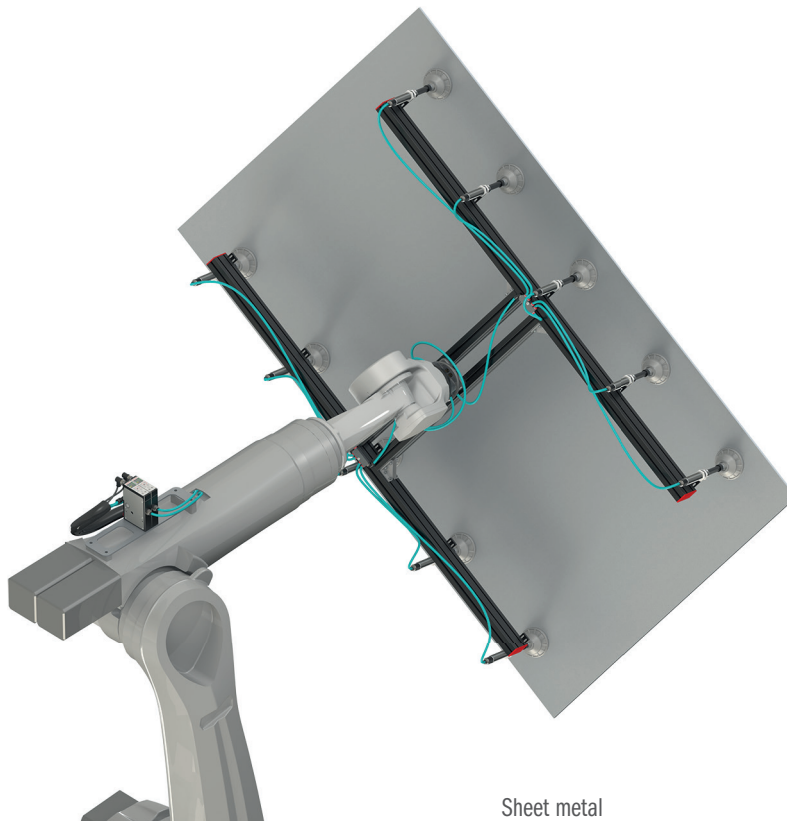



Plastic

- > Plastic injection molding - medium / large sized parts (e.g. automotive parts)

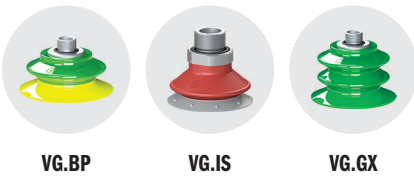

Packaging

- > Palletizing robots
- > Medium-sized robots for top loading (including the simplest 2-3 axis manipulators)
- > Handling of bags and opening bags
- > Interlayer manipulation

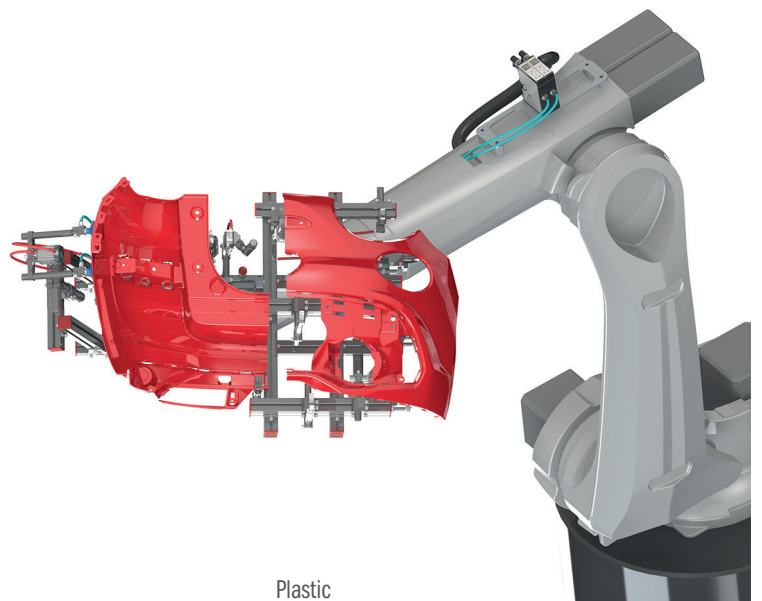
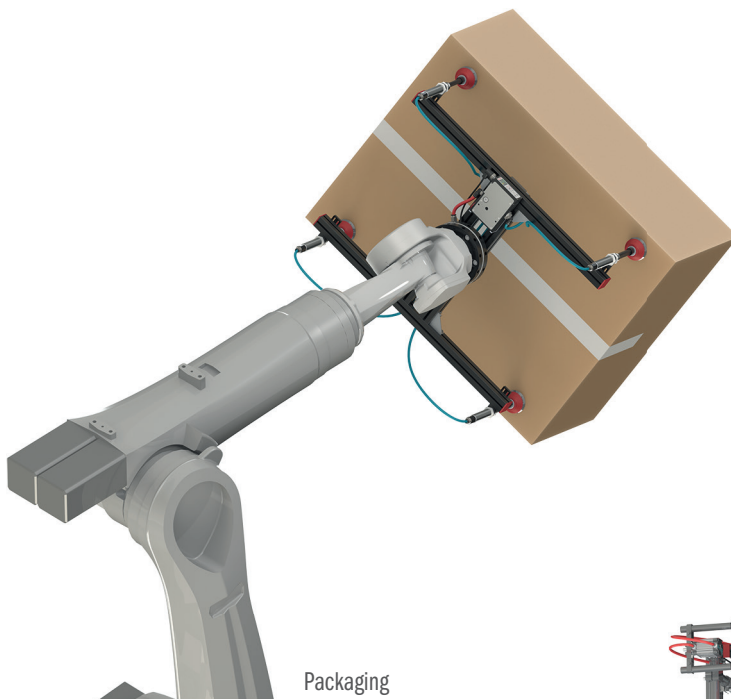



Ordering codes

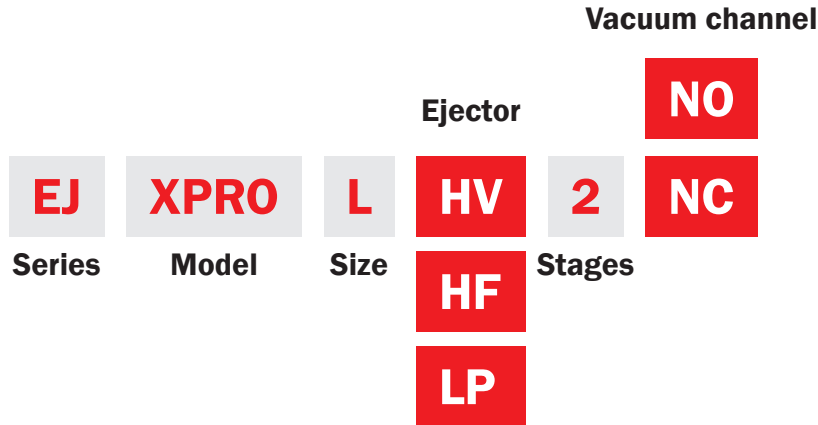

3400100	EJ-XPRO-L-HF-2-NO	Electronically controllable vacuum pump with embedded electro-valves, display, keyboard, M12 8 pins connector. HF 2 stages ejector and not-return valve and NO vacuum channel. Configurable PNP/NPN, 24Vdc logic.
3400101	EJ-XPRO-L-HV-2-NO	Electronically controllable vacuum pump with embedded electro-valves, display, keyboard, M12 8 pins connector. HV 2 stages ejector and not-return valve and NO vacuum channel. Configurable PNP/NPN, 24Vdc logic.
3400102	EJ-XPRO-L-LP-2-NO	Electronically controllable vacuum pump with embedded electro-valves, display, keyboard, M12 8 pins connector. LP 2 stages ejector and not-return valve and NO vacuum channel. Configurable PNP/NPN, 24Vdc logic.
3400103	EJ-XPRO-L-HF-2-NC	Electronically controllable vacuum pump with embedded electro-valves, display, keyboard, M12 8 pins connector. HF 2 stages ejector and not-return valve and NC vacuum channel. Configurable PNP/NPN, 24Vdc logic.
3400104	EJ-XPRO-L-HV-2-NC	Electronically controllable vacuum pump with embedded electro-valves, display, keyboard, M12 8 pins connector. HV 2 stages ejector and not-return valve and NC vacuum channel. Configurable PNP/NPN, 24Vdc logic.
3400105	EJ-XPRO-L-LP-2-NC	Electronically controllable vacuum pump with embedded electro-valves, display, keyboard, M12 8 pins connector. LP 2 stages ejector and not-return valve and NC vacuum channel. Configurable PNP/NPN, 24Vdc logic.



General characteristics

Operating temperature range	0-60 °C
Mass	800g
IP rating	IP54
Materials	Lega 6082-T6, PA66+FG 30%, AISI 303, TPU, PC
Operating voltage	24Vdc (±10%)
Electrical connection	M12 8-pin male
Manual controls	Yes, monostable buttons
Vacuum transducer response time	1ms
Vacuum level analogue output	0-5Vdc
Valve controls	digital PNP/NPN



Pneumatic characteristics

Maximum supply pressure	8bar
Minimum supply pressure	4bar
Maximum air consumption for vacuum generation	156NI/min
Maximum air consumption for blow-off	220NI/min
Maximum blow-off flow rate	50NI/min
Maximum suction flow rate	190NI/min
Maximum blow-off pressure (zero flow rate)	0.25bar
Valve opening time	≤ 12ms
Valve closing time	≤ 5ms
Supply	Dry air
Pneumatic supply connection	G1/4 female
Vacuum channel connection	G1/2 female
Maximum vacuum level	-95kPa



Suction flow rate

Model	Feed pressure [MPa]	Air consumption [NI/s]	Suction flow rate [NI/s] at different vacuum levels [-kPa]										Max vacuum [-kPa]
			0	10	20	30	40	50	60	70	80	90	
EJ-XPRO-L-HF-2-NO/NC	0.6	1.7	3.2	3.0	2.5	1.7	0.89	0.62	0.51	0.31	–	–	73
EJ-XPRO-L-HV-2-NO/NC	0.5	1.93	2.6	2.4	1.7	1.3	0.70	0.55	0.40	0.31	0.15	0.02	94
EJ-XPRO-L-LP-2-NO/NC	0.4	2.6	2.8	2.5	2.1	1.5	1.1	0.66	0.36	0.26	0.08	–	89



Evacuation time

Model	Feed pressure [MPa]	Air consumption [NI/s]	Evacuation time [s/l] to reach different vacuum levels [-kPa]									Max vacuum [-kPa]
			10	20	30	40	50	60	70	80	90	
EJ-XPRO-L-HF-2-NO/NC	0.6	1.7	0.03	0.07	0.12	0.19	0.3	0.4	0.7	–	–	73
EJ-XPRO-L-HV-2-NO/NC	0.5	1.93	0.02	0.06	0.10	0.2	0.3	0.4	0.7	1.1	2.4	94
EJ-XPRO-L-LP-2-NO/NC	0.4	2.6	0.04	0.07	0.14	0.19	0.3	0.5	0.8	1.4	–	94



Via Enzo Ferrari, 2/4
25030 Roncadelle (BS) ITALY

tel. +39 030 2584655
fax +39 030 2583886

info@gimatic.com
www.gimatic.com



Sales Network