

MRK GUIDE



CATALOGS

- 3 **Condition**
- 4 **Gimatic Guide Lines**
- 6 **Exhibition Check List**
- 9 **Brochure**
- 10 **Vacuum Catalogue**
- 11 **EOAT Catalogue**
- 12 **BROCHURE - FLYER**
- 13 **USB-MOVIE**
USB-MOVIE-V

EXHIBITIONS

- 14 **Booth Graphic**
- 15 **Booth accesories - Gadget - Corporate accesories**
- 20 **WOOD BOXES - CARTON BOXES**
- 21 **PAN MULTILANGUAGE**
PAN APPLICATION
- 22 **PAN MULTILANGUAGE**
PAN-31, PAN-32, PAN-33, PAN-36, PAN-37, PAN-38
- 23 **PAN MULTILANGUAGE**
PAN-39, PAN-40, PAN-41, PAN-43, PAN-44, PAN-45
- 24 **PAN MULTILANGUAGE**
PAN-47
- 25 **DISPLAY-25**
Plastics demo display (4x)
EOAT demo display (1x)
- 27 **DISPLAY-27**
EOAT demo display
- 29 **DISPLAY-27-7**
EOAT with headlight lens
- 30 **DISPLAY-31 e DISPLAY-37**
EOAT demo display & Carbon Fiber Eoat
- 31 **DISPLAY-36**
Handling-Mechatronics demo display (4x)
- 33 **DISPLAY-42**
Bumper demo display
- 35 **DISPLAY-46**
Bumper demo display
- 37 **DISPLAY-50**
Robot display
- 39 **DISPLAY-51**
EOAT Demo display

- 40 **DISPLAY-52**
Vacuum display
- 42 **DISPLAY-53**
Demo display Vacuum
- 44 **Tool box**
- 45 **START-CASE**
SB2T
- 46 **VACUUM CASE**
- 47 **HANDLING-MECHA-CASE**
HANDLING BLISTER
MECHA BLISTER
- 48 **PLASTICS-CASE**
PLASTICS-BLISTER-01
PLASTICS-BLISTER-02
PLASTICS-BLISTER-03
- 49 **Contact document**
- 51 **Exhibition booth examples**
- 52 **Trade exhibition review**

PAPER AND WEB MARKETING

- 54 **PAPER MARKETING**
COVER STORY
INTERNAL ADVERTAISE
EDITORIAL
CASE HISTORY
- 55 **Paper Marketing Check List**
Paper Marketing Plan
- 56 **WEB MARKETING**
SOCIAL
PORTALS
- 57 **Web Marketing Check List**
Web Marketing Plan

CONDITIONS

We kindly ask you to spend a little part of your precious time to think and communicate us the events/fairs you will intend take part to, when they will be exactly and which material you would like to show.

To make easy this organization, we think that the present guide could help you.

In this guide you could find some memo to arrange an event, the material list that Gimatic makes available for that (advertising material, gadget, frames/displays of all our products) and relative ordering codes.

PRICES

As you could see on this guide, we have thought to give you the possibility to buy at a special price some optional for expo only like bag-older, brochure table and so on.

About catalogues, considering the importance of the advertising material we are using, we are compelled to apply a symbolic price to avoid an indiscriminate distribution.

We repeat the importance of a good organization and we push you to look at our Marketing Guide and book as soon as possible the necessary goods for your event.

Please send your “official order” using ordering codes that you can find on this manual. We will try to satisfy all your needs.

SHARING COSTS

At least but not last, the important topic of “costs”: it will be very helpful for Gimatic to get an idea of the “fees” necessary to participate to the event we are going to arrange. In the last pages of this guide there is an Exhibition Report (you can ask for an excel version) which will help you with the budget of your exhibition.

Gimatic wants to participate at the exhibition costs and do it paying one way of the transport. This means we organize and pay the pick-up of the goods from our warehouse to the destination (exhibition or Companies); otherwise the return of the goods it's up to the distributor/subsidiary.

This means the recipient has to follow all the parts of the transport, not only the cost but its organization too. The distributor/subsidiary has to be interested in all the activities and be the referent of its exhibition.

REFOUND

The distributor/subsidiary must be diligent in checking the integrity of the goods on arrival, otherwise it will be considered directly responsible to GIMATIC for any loss or damage, even if the liability of the carrier.

The distributor/subsidiary is responsible for the goods ordered until its return in our warehouse; Gimatic reserves the right to invoice the damage goods or those not returned back.

GIMATIC GUIDE LINES

In order to increase the brand awareness and have the same image worldwide we like to establish some Guide lines:

LOGO

Use the same Gimatic Logo(e.g. do not use Gimatic France, Gimatic Iberia,...)

Use the same colours tone of red and grey as Gimatic Hq:



EXHIBITIONS



All the booths must have the same style and concept (see the photo) , send us an idea or sketch for the approval, you can contact us before if you need some help.

Please Note:

It's very importante, after the exhibition , to fill and send back the Exhibition Report.

it is also necessary to enter the Leads collected at the fair and the contacts who visited the stand in the CRM, with the correct method and following the lead journey.

PHOTO



As we all use Office 365 we should align the photo in the e-mail (same white back ground colour, see the example)

BUSINESS CARD



- Now all business cards must be ordered from the platform created by Barnes. For any information, send an email to the Marketing Dept.

EXHIBITION CHECK LIST

Ask excel version to Gimatic

Our goal is to define Best Successful Points for Successful Exposition as follow:

Year Before

- Have you found the Best Exhibition for our Market in your area (Plastics, Handling, Mecha, Sens)?
- Have you seen previous Exhibition Report (visitors, exhibitors...)?
-
-

Months Before

- Have you defined appropriate exposition dimensions floor (price/sq.m)?
- Who realize the booth structure (price)?
- There is Exhibition Advertise opportunity?
- Have you chosen Dynamic Displays as your space?
- Do you have checked exhibition facilities (Electricity, Air pressure, ...)?
- Have you chosen Static Displays for wall or totem application?
- Do you need any Demo-Case on the booth?
- How many Catalogues do you need, languages?
- It is necessary to provide Price Lists with Plastic Catalogue?
- How many Brochures do you need?
- Do you have brochures multilayer holder?
- Do you need USB for monitors or LCD screen?
- Do you want any USB for customers?
- How many Gimatic Bags you need? (n° of visitors, days, ...)
- Do you have special brackets to hold them?
- How many Gimatic Pens you need?
- Do you want some Gimatic USB for key customers?
- Do you want different Gimatic Gadget such as Business Card Holder?
- Have you plan Good deliveries ?
- Have you plan Accommodation?
- Have you plan people Transportation?
-
-
-
-

Weeks Before

- Do you need Coffee machine at the booth?
- Have you engaged Sales people?
- Do they need any Sales training?
- Do you need Gimatic Sales/Technical people?
- Have you engaged Hostess with language skills, if necessary?
- Do you need Gimatic products samples?
- Do you think is necessary to attend or arrange After show events?
-
-

Days Before

- Have you arrange booth cleaning?
- Do you have contacts leads document?
- Have you prepared Food and Beverage?
- Define an appropriate dress code?
- Define appropriate behaviour rules which have to be followed on the stand
- Check that all the material exposed on the stand is not damaged and that works perfectly
- Define the exhibition main themes/arguments
- Define the person in charge for all the things that concentering the stand
-

During Exhibition

- Check competitors booth location and visit them
- Collect as many contacts as possible using our "contact document"
- Check that all the display exposed are working in the right way
-
-

After Exhibition

- Fill the excel file with all the contacts collected in order to make a segmentation
- Remember to scan each contact document and give it the same number of the excel file
- Thanksgiving send a mail to everyone who has visited you to say thanks
- Send all the material requested (catalogues, brochures...)
- Inform the Gimatic HQ about any suggestion/improvement
-

VACUUM CATALOGUE



	Languages	Edition	Format	Package
CAT-VACUUM-2022-EN	EN	08/2022	A4 (21x29.7 cm) 516 pages	13 copies for box
CAT-VACUUM-2022-IT	IT			

	Languages	Edition	Format
CAT-VACUUM-2022-US	USA	08/2022	ONLY PDF VERSION (available online)
CAT-VACUUM-2022-DE	DE		
CAT-VACUUM-2022-FR	FR		
CAT-VACUUM-2022-ES	ES		
CAT-VACUUM-2022-PT	PT		
CAT-VACUUM-2022-PL	PL		
CAT-VACUUM-2022-CZ	CZ		
CAT-VACUUM-2022-RU	RU		
CAT-VACUUM-2022-RO	RO		
CAT-VACUUM-2022-BG	BG		
CAT-VACUUM-2022-TR	TR		
CAT-VACUUM-2022-CN	CN		
CAT-VACUUM-2022-JP	JP		
CAT-VACUUM-2022-KR	KR		
CAT-VACUUM-2022-HU	HU		
CAT-VACUUM-2022-SE	SE		
CAT-VACUUM-2022-TH	TH		

EOAT CATALOGUE



	Languages	Edition	Format	Price
CAT-2023-DE-EN	DE-EN	01/2023	A4 (21x29.7 cm) 698 pages	13,70€

	Languages	Edition	Format	Package
CAT-2023-IT-EN	IT-EN	01/2023	A4 (21x29.7 cm) 698 pages	ONLY PDF VERSION (available online)
CAT-2023-RU-EN	DE-EN			
CAT-2023-FR-EN	FR-EN			
CAT-2023-ES-EN	ES-EN			
CAT-2023-PT-EN	PT-EN			
CAT-2023-PL-EN	PL-EN			
CAT-2023-CZ-EN	CZ-EN			
CAT-2023-TR-EN	TR-EN			
CAT-2023-CN-EN	CN-EN			
CAT-2023-JP-EN	JP-EN			

BROCHURE



Ask PDF versions to Gimatic



Brochure available:

EJ-XPRO	BRO-EJXPRO-EN BRO-EJXPRO-IT	1,50€
Medical	FLYER-MEDICAL-EN FLYER-MEDICAL-IT	0,60€
Vacuum	FLYER-VACUUM-EN FLYER-VACUUM-IT	0,50€
Cobot	FLYER-COBOT-EN FLYER-COBOT-IT	0,60€
Rfid	FLYER-RFID-EN FLYER-RFID-IT	0,40€
Mold Monitoring	FLYER-MOLD-EN FLYER-MOLD-IT	0,40€
Eoat	FLYER-EOAT-EN FLYER-EOAT-IT	0,60€
Global Company	FLYER-GLOBAL-EN FLYER-GLOBAL-IT	0,40€
Product Overview	BRO-PRODUCTS-2023-EN BRO-PRODUCTS-2023-IT	0,30€
Foam Gripper	BRO-FOAM-EN BRO-FOAM-IT	0,50€

FLYER



Ask PDF versions to Gimatic

Symbolic price:
€ 0,10

Flyers available:

ZL-Pneumatic Sliders
Quick Changers (Coming Soon)
PT-Needle Grippers
IO-Link
One Finger Grippers
OFN-Tilt Unit
Servo Gripper
MAG



USB MOVIE

Ask to MRK DEPT. to know the Gimatic videos available.



	Type file	Package	Weight carton box	Symbolic price
USB-MOVIE-V (Various movie)	.mp4 .mov .avi	Carton box	0,015 kg	€ 7,00

BOOTH GRAPHIC

Ask to Marketing Dep.

Examples

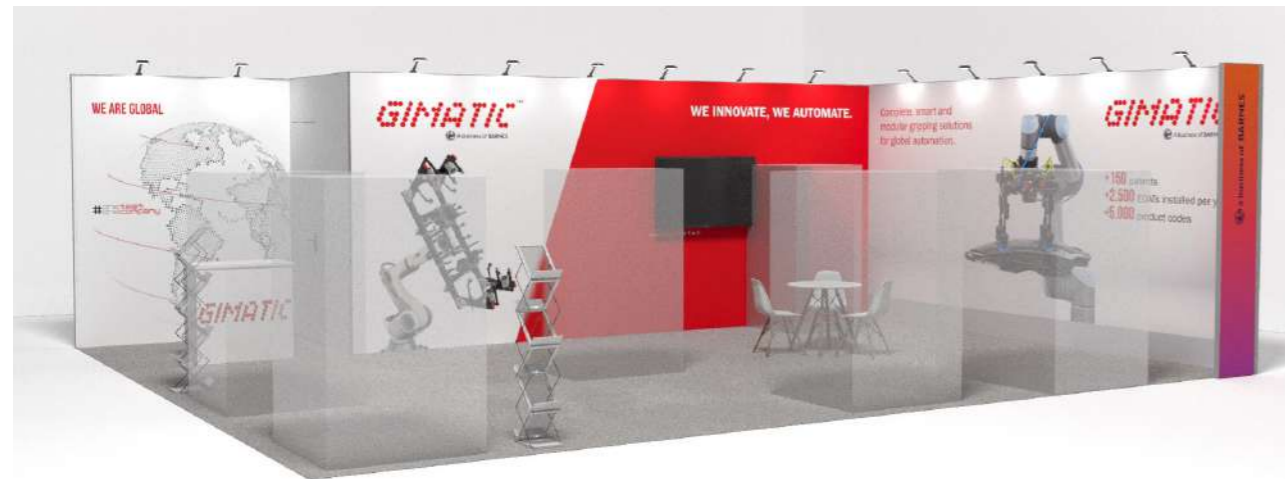
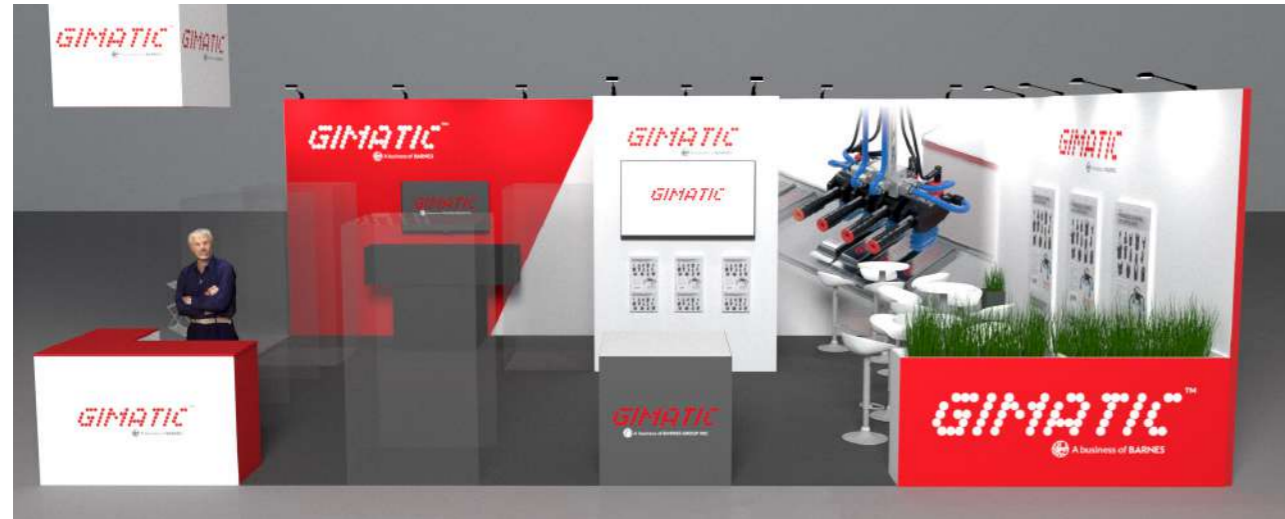

BOOTH ACCESSORIES



BROCHURE-TABLE
1 piece/box
0.7 kg
carton size 33 x 23 x 12 cm
Free for exhibition
€ 17



BROCHURE-STAND
1 piece/box
Open: 27.5 x 37 x 150 cm
carton size 47 x 14 x 33 cm
7 kg
Free for exhibition - Only for exhibition



SHELF-UNIT
1 piece/box
Open 90 x 90 x 35
carton size 93 x 37 x 11 cm
8 kg
Free for exhibition
€ 80,00



BAG-HOLDER
1 piece/box
carton size 35 x 35 x 100 cm
4,7 kg
Free for exhibition
€ 85,00



DISPLAY-COVER
1 piece/box
Free for exhibition
€ 11



FIRST-AID
1 piece/box
30 x 14 x 46 cm
7,5 kg
Free for exhibition
€ 20,00



TROLLEY
1 piece
75 x 25 x 47 cm
8,5 kg
Free for exhibition
€ 50,00



STAIR
1 piece
110 x 20 x 50 cm
5,6 kg
Free for exhibition
€ 50,00



WASTE-BASKET
1 piece
31 x 31 x 32
0,2kg
Free for exhibition
€ 3,00



GARBAGE-BAG
1 piece
6 x 6 x 15
0,2 kg
€ 1,50



PEN-HOLDER
1 piece
0,06 kg
Free for exhibition
€ 2,00
10 x 8 x 8 cm



CONTACT-FOLDER
1 piece/box
35 x 29 x 8 cm
Free for exhibition
€ 4,50



PAPER-PUNCH
1 piece
0,2 kg
Free for exhibition
€ 22,00



STAPLER
1 piece/box
0,2 kg
Free for exhibition
€ 17,50



CLEANING-KIT
1 piece
Paper Roll + Spray Detergent
20 x 15 x 31 cm
1 kg
€ 8,00



DUST-CAPTURE
3 piece/box
€ 8,00



STICKER-32
1 piece
32 X 9 cm
€ 3,00



STICKER-56
1 piece
56 X 15,8 cm
€ 6,00



PLATE
1 piece
0,1 kg
13,5 x 9 cm x 1mm
€ 5,00

The table on the plate is empty to let the user write the EOAT details needed.



TAPE-ROLL
1 piece
0,3 kg
€ 2,50

GADGET



DIARY
1 piece
0,08 kg
19 x 21 cm
€ 3,50

50 pieces/box
13,5 kg
carton size 36,5x31,5x23 cm



NOTE
A4 / 21 x 29,7 cm
5 piece/cellophane package
2,6 kg
20 piece/carton size 32 x 25 x 24 cm
10,5 kg
€ 1,50/piece (Minimum order 5 pieces)



NOTEBOOK
1 piece
0,08 kg
19 x 21 cm
€ 3,00

36 pieces/box
10,6 kg
carton size 26x23x30



PEN
Pen
100 pcs/box
1 kg
carton size 14.5 x 14.5 x 9 cm
€ 0,40

1.000 pieces/carton box
10,3 kg
carton size 47.5x31.5x16.5



PENCIL
1 piece
0,04 kg
€ 0,40

200 pieces/carton box



TABLE-CALENDAR
Calendar with Italian bank holidays
1 piece
0,08 kg
€ 2,00



VR-VIEWER
1 piece/box
0,35 kg
carton size 20 x 14 x 11 cm
FREE

50 pieces/carton box
18 kg
carton size 71x41x58 cm



ALLENKEY
The sizes are
1.5/2/2.5/3/4/5/6
0,6 kg
carton size 10 x 10 x 15 cm
€ 4,00

120 pieces/carton box
16.30 kg
carton size 31x27x17 cm



ROLL UP
1 piece
Open Height: 220 cm
carton size 110 x 55 x 20
2,1 kg
Free for exhibition.
€ 100,00



FLAG
1 piece
Open Height: 240 cm
carton size 110 x 55 x 20
2,1 kg
Free for exhibition.
€ 140,00



GIMATIC-FOREX
1 piece
€ 20,00
The price can change.

size 97x26 cm
0,4 kg



CHARGER
1 piece/box
Wireless battery charger.
USB cable/microusb included.
(The device has just to be placed on the charger station. Generally this charger is suitable for the devices that have the Qi technology integrated.)
5W
0,1 kg
€ 6,50

100 pieces/box
6,5 kg
carton size 51,5x26x27 cm

CORPORATE ACCESSORIES



NAME-PLATE
1 piece
Paper 7,9 x 4,9 cm
€7,00



PIN
1 piece
3 x 1 cm
€ 1,20



ADAPTER-PLUG
1 piece
0,1 kg
€ 4,00



50 pieces/box
5 kg
carton size
46x28x12 cm



CAP
1 piece
0,1 kg
€ 4,00



HOODIE
Size: M/L/XL
28/31 pieces/box
0,1 kg
€20,00

carton size 40x42x58
13 kg



BAG
100 pieces/box
carton size 35 x 45 x 34 cm
6,4 kg
€ 0,80



POLO
Size: L
1 piece
0,3 kg
€ 8,00

24 pieces/box
6kg
carton size 52 x 38 x 20 cm



SCARF
1 piece
0,01 kg
€ 30,00



UMBRELLA
1 piece
0,40 kg
€ 10,00

24 piece/box
11 Kg
carton size 39 x 23 x 33 cm

WOOD BOXES

6 position

93 cm
65 cm
210 cm
90 kg

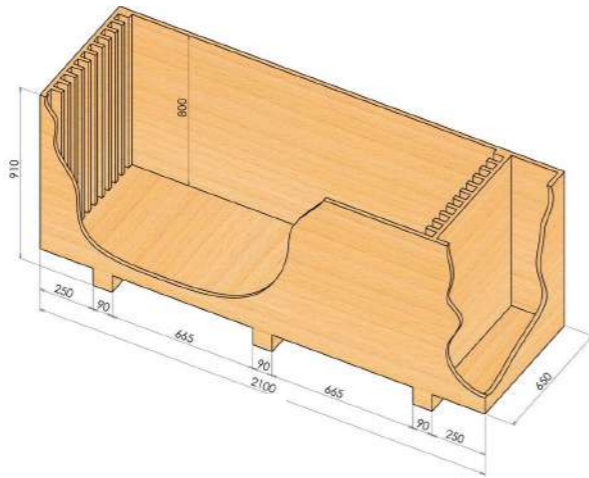

12 position

93 cm
95 cm
210 cm
100 kg

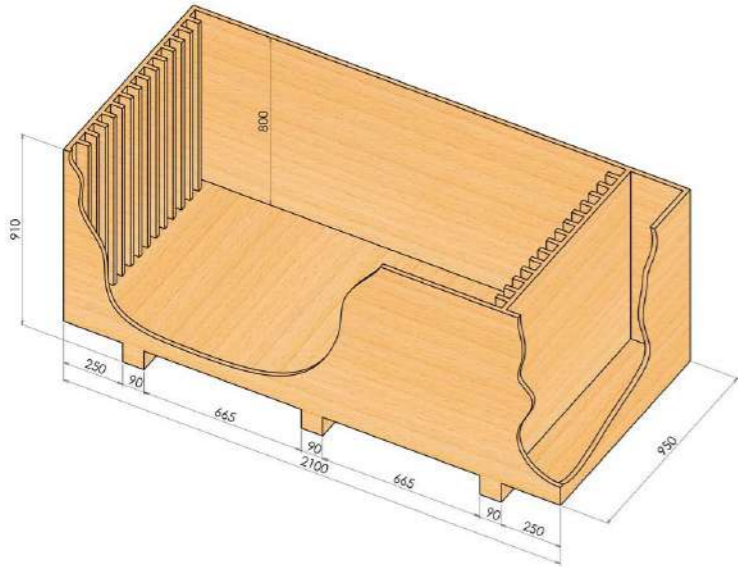

CARTON BOXES



26 cm
17 cm
21,5 cm

SCAT.PICCOLA
20 pcs pack
€ 0.26/each
Dimensions: 260X170X215mm H



37 cm
27,5 cm
24 cm

SCAT.MEDIA
10 pcs pack
€ 0.62/each
Dimensions 370X275X240mm H



58,5 cm
39 cm
28 cm

SCAT.GRANDE
10 pcs pack
€ 1.17/each
Dimensions 585X390X280mm H

PAN MULTILANGUAGE

Available languages



180 cm
2+20 cm
77 cm

To delivery them you can use our standard wood boxes With 6 or 12 positions. See on page 29



PAN-APPLICATION

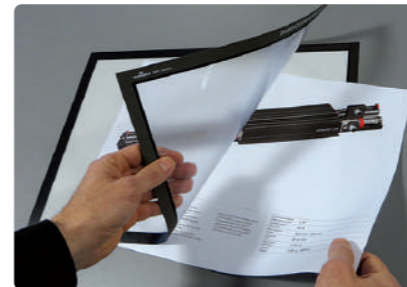

Multilanguage panels application layout. It is possible to use our MFI fixing plates to realize different positioning.

PAN MULTILANGUAGE

PAN-31
MPPM, MPXM, MPLM, MPTM
10 kg



PAN-32
MPBM
11 kg



PAN-33
EQC, ML, LV, LVP
13 kg



PAN-39
DH, TH, PQ
10 kg



PAN-40
MGX, GM, MG
10 kg



PAN-41
MFD, MFU
10 kg



PAN-36
RT, R
10 kg



PAN-37
SGP-S, GS, GW, GX
11 kg



PAN-38
SX, SXT, SZ, SH
14 kg



PAN-43
SENSORS
9 kg

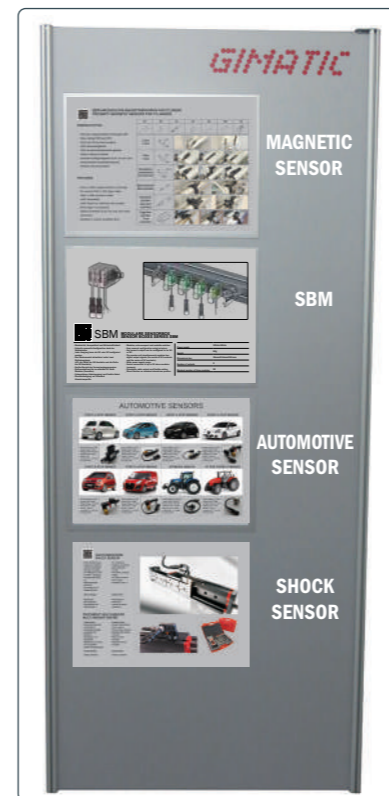

PAN-44
SPECIAL
9 kg

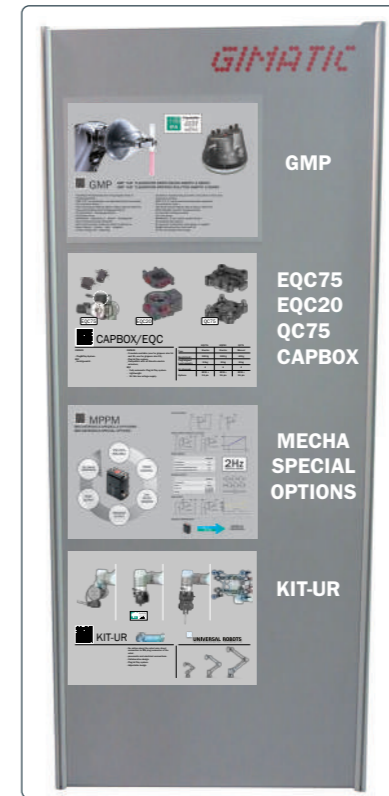

PAN-45
GIMATIC GROUP
9 kg



PAN MULTILANGUAGE

PAN-47
INDUSTRY 4.0
9 kg



DISPLAY-25

Display demo Plastics (1-2-3-4) + EOAT demo display (5)

DISPLAY-25-1
DISPLAY-25-2
DISPLAY-25-3
DISPLAY-25-4

DISPLAY-25-5

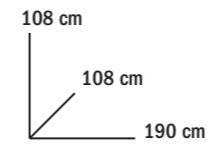

DELIVERY WOOD BOXES
100 kg

Phytosanitary treatment is not necessary due to the plywood material (ISPM-15)

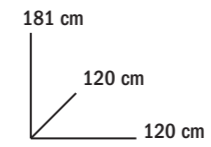

ASSEMBLED FRAME
110 kg

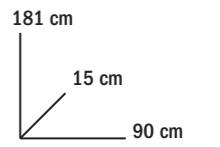

SINGLE FRAME
32 kg

Power supply	220 Vac
Air Connection	pipe Ø8

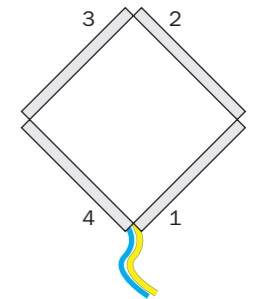

Combine 1-2-3-4 frames as picture



Fix frames with 4 brackets on the top and 4 brackets on the top

Connect Air connection pipes

DISPLAY-25

Mounting Frame Gimatic logo on demo display

- A: DISPLAY25 logo mounted in the lower part of the frame for the transport
- B: Knobs to unscrew to remove the logo
- C: Pull up carefully (use two hands)



- D: Locking pin
- E: Place the logo on the top of the frame by aligning the pins with the holes
- F: DISPLAY25 logo mounted in the right mode for the exhibition

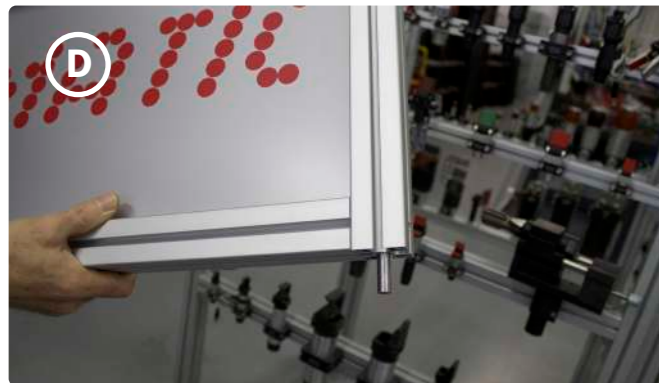

DISPLAY-27

E0AT demo display

185 cm
120 cm
158 cm
ASSEMBLED FRAME
70 kg

200 cm
99 cm
99 cm
DELIVERY WOOD BOXES
100 kg
Phytosanitary treatment is not necessary due to the plywood material (ISPM-15)

Power supply	220 Vac
Air Connection	pipe Ø8

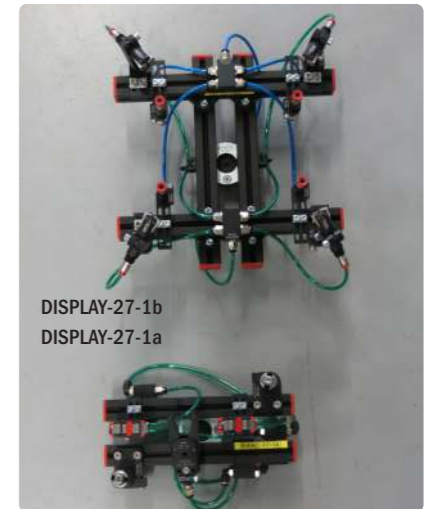
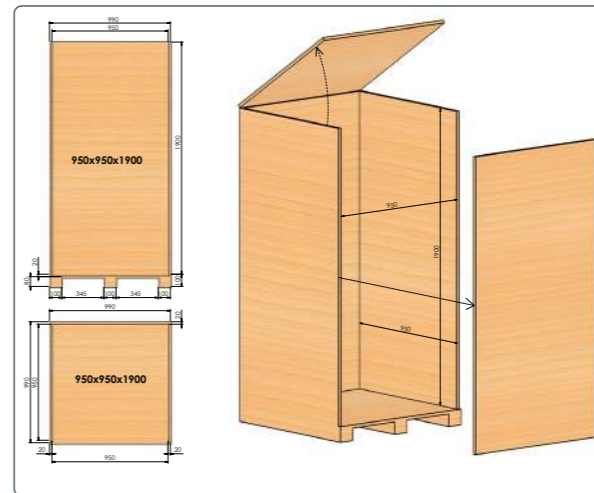

DISPLAY-27

EOAT demo display



DISPLAY-27-7

EAOT with headlight lens

30 cm
40 cm
60 cm
DELIVERY WOOD BOXES
5,8 kg



EMF-2525-2000	1
QCY90-A	1
QCP90-B	1
CQC-012	1
CQC-013	1
MAQC	1
MBQC	1
CEQC-BC	1
DD20-16L2	2
OFR20-95G	2
MFI-A350	3
AV0118M16	4
COJ12	1
SBMM	1

SBMK	1
SBMS	3
RAQC	1
RBQC	1
MFI-A140	4
MFI-A38	4
DD20-16M2	1
MFP-A06	1
V0233H04	4
MFI-A21	1
RG.5511600004	1
MFI-A379	1
MFI-A239	1
MFI-A252	3

SS3N203Y-1	3
VSE2050F18	4
G.N20PF	1
GN-20	1
OF20L100	1
RG.5002000N03	1
RG.5511600013	1
3330082	1
MFI-A217	1

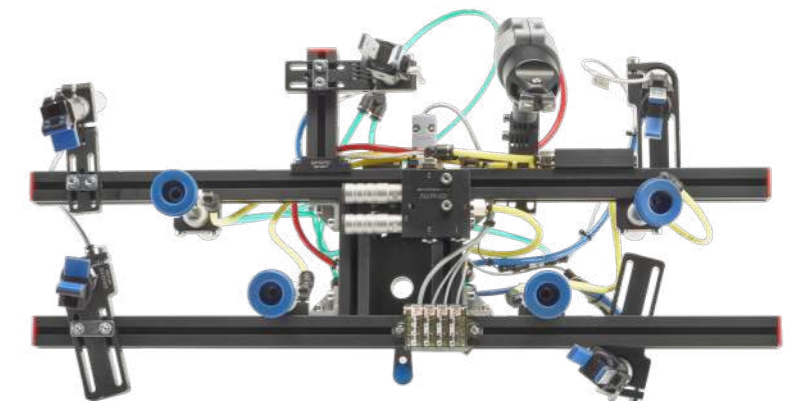
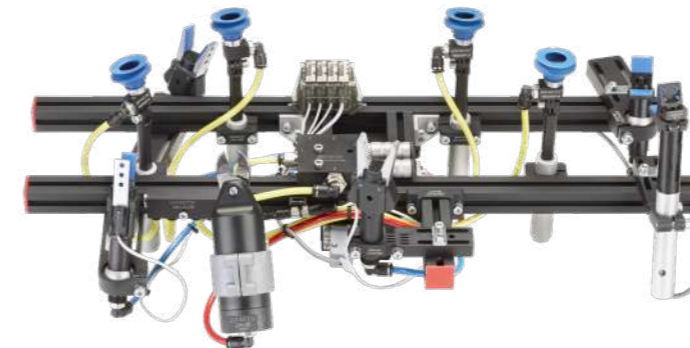

DISPLAY-31

Ultralight fiber carbon tubes



178 cm
67 cm
82 cm
FRAME
29.5 kg

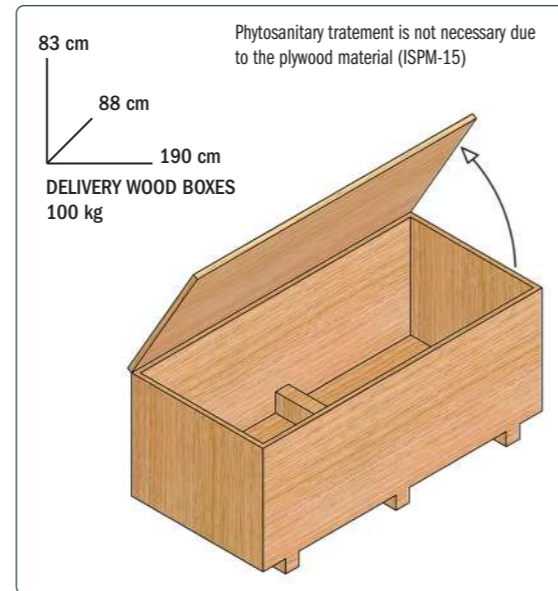

83 cm
88 cm
190 cm
DELIVERY WOOD BOXES
100 kg
Phytosanitary treatment is not necessary due to the plywood material (ISPM-15)



ALUMINIUM EOAT
10.4 kg

CARBON FIBER EOAT
5.6 kg

DISPLAY-37

Fiber Carbon EOAT

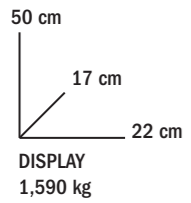

DISPLAY
1,590 kg

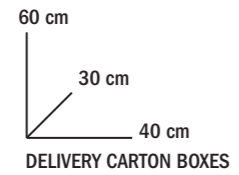

DELIVERY CARTON BOXES

TFC-2017-1500	1
QC90-A	1
QC90-B	1
MFI-A328	1
MFP-K22	1
MFI-A191	4
AV0118M12	4
V0233H04	4



DISPLAY-36

Handling-Mechatronics demo display (1-2-3-4)

Power supply	220 Vac
Power Max	1100 W
Power Consumption	360 Wh
Air Connection	Pipe Ø8

DISPLAY-36-1
DISPLAY-36-2
DISPLAY-36-3
DISPLAY-36-4

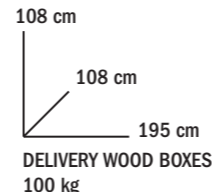

DELIVERY WOOD BOXES
100 kg

Phytosanitary treatment is not necessary due to the plywood material (ISPM-15)

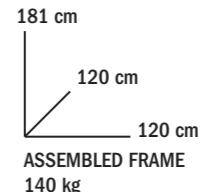

ASSEMBLED FRAME
140 kg

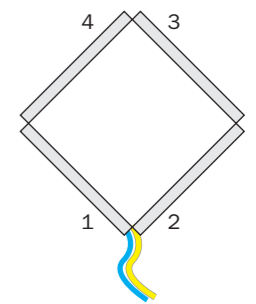

Combine 1-2-3-4 frames as picture



Fix frames with 4 brackets on the top and 4 brackets on the bottom

Connect Air connection pipes

DISPLAY-36

Mounting Frame Gimatic logo on demo display

- A: DISPLAY36 logo mounted in the lower part of the frame for the transport
- B: Knobs to unscrew to remove the logo
- C: Pull up carefully (use two hands)



- D: Locking pin
- E: Place the logo on the top of the frame by aligning the pins with the holes
- F: DISPLAY36 logo mounted in the right mode for the exhibition



DISPLAY-42

Bumper demo display

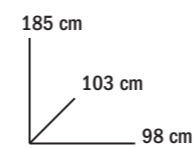

ASSEMBLED FRAME
70 kg

Free for exhibition

€ 2000,00 (in case of buying)

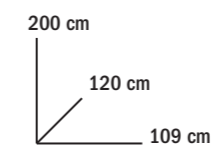

DELIVERY WOOD BOXES
115 kg

Phytosanitary treatment is not necessary
due to the plywood material (ISPM-15)

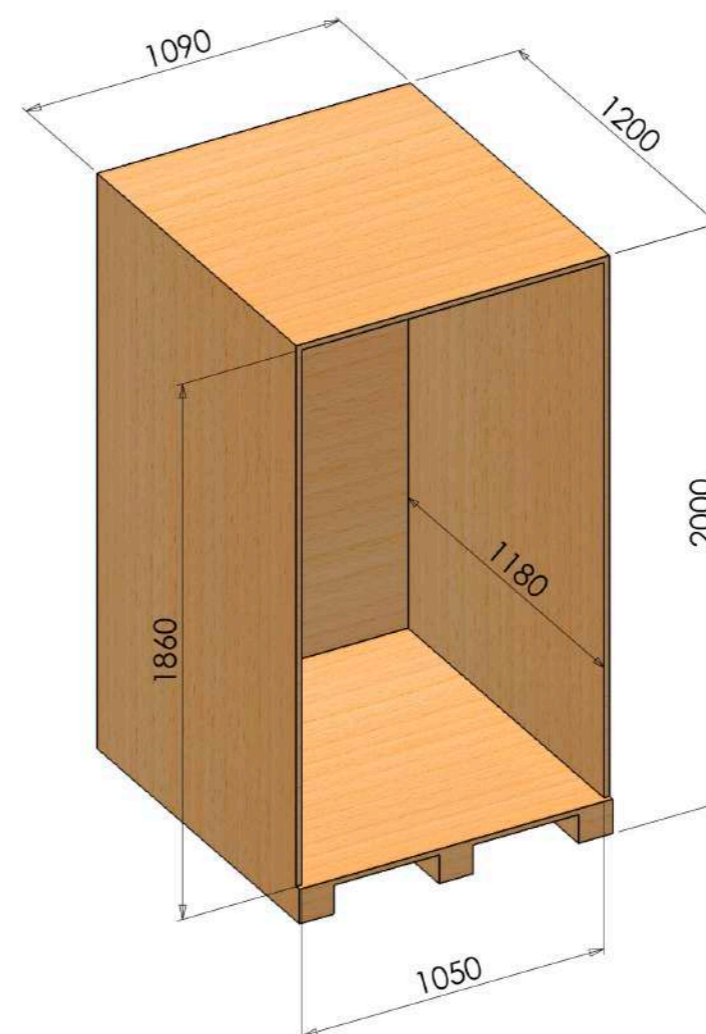

DISPLAY-42

Bumper demo display

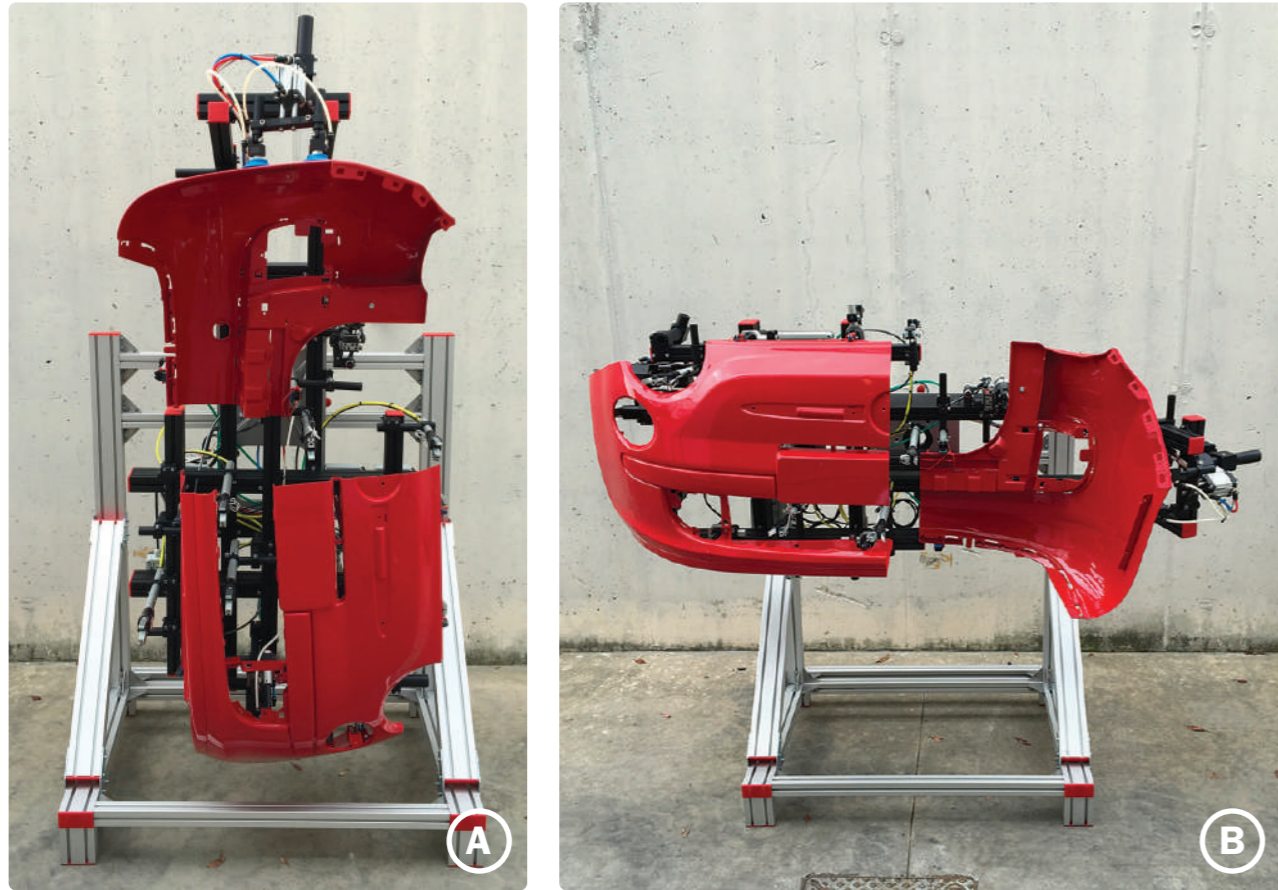

It's possible to show this display in two position, vertical or landscape mode.

The default position is vertical but it is possible to change it unscrewing the screws placed between the quick changer and the frame.

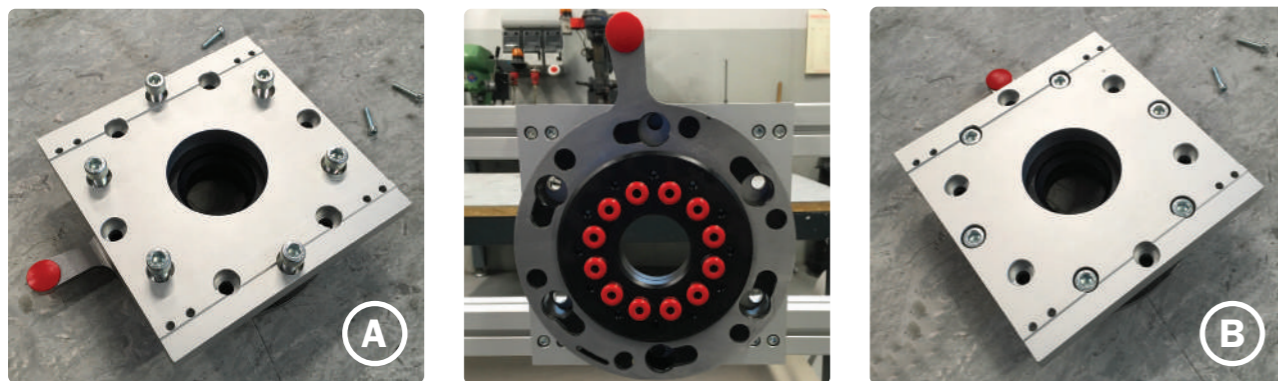

A: Vertical Config.

B: Landscape Config.

DISPLAY-46

Bumper demo display

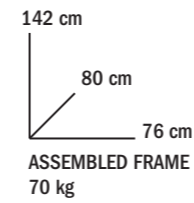

Free for exhibition

€ 2000,00 (in case of buying)

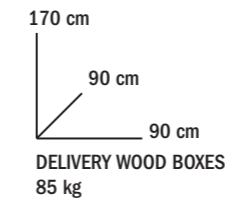

Phytosanitary treatment is not necessary due to the plywood material (ISPM-15)

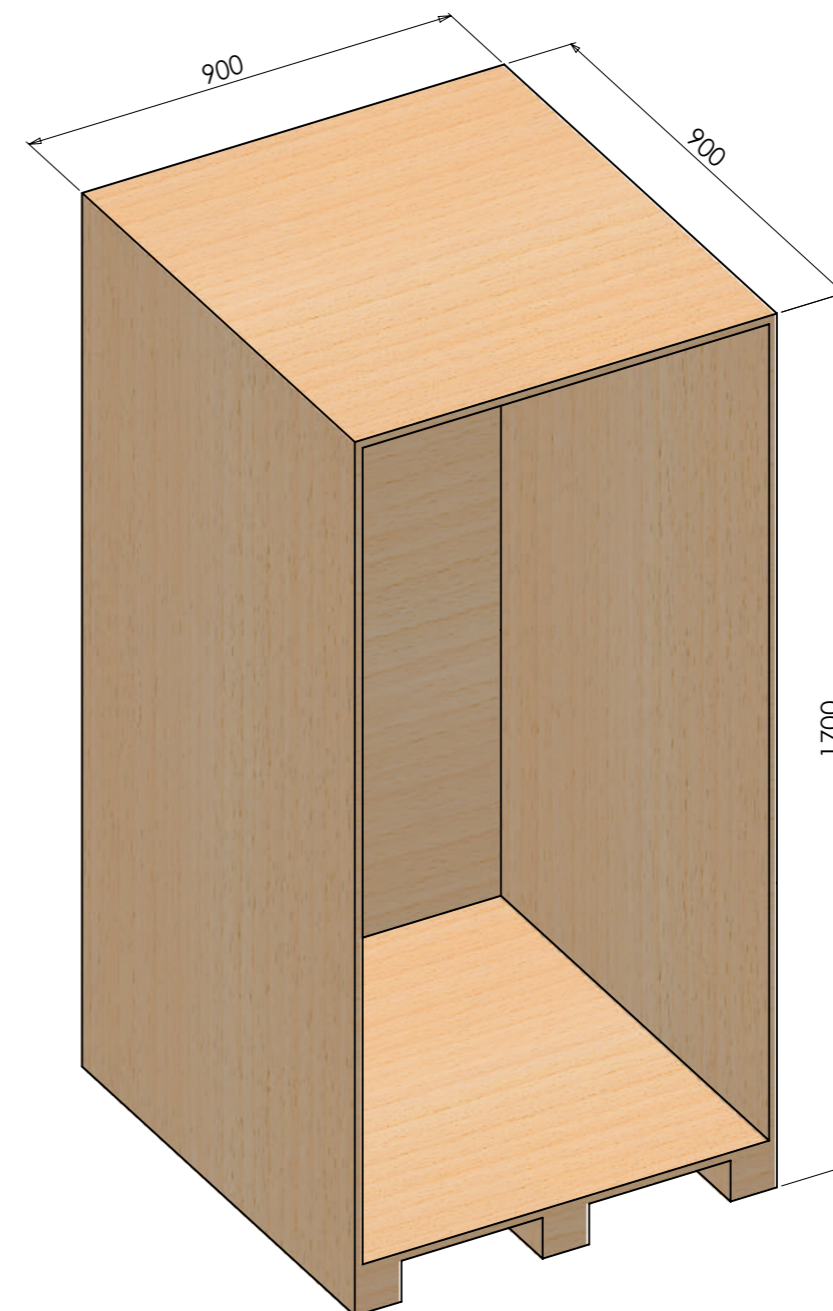

DISPLAY-46

Bumper demo display

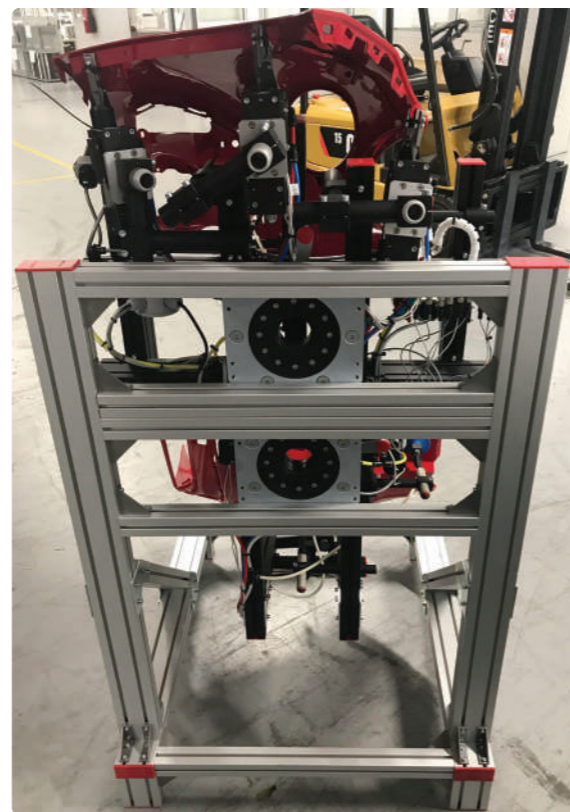
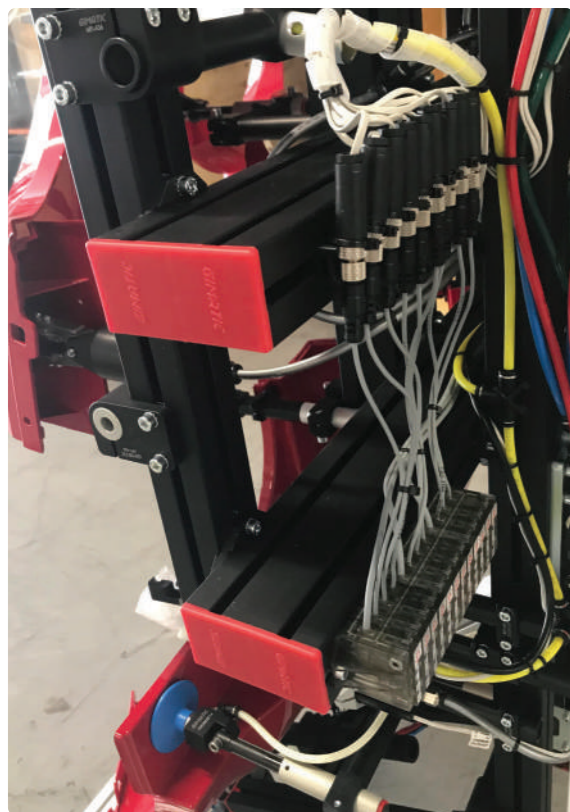
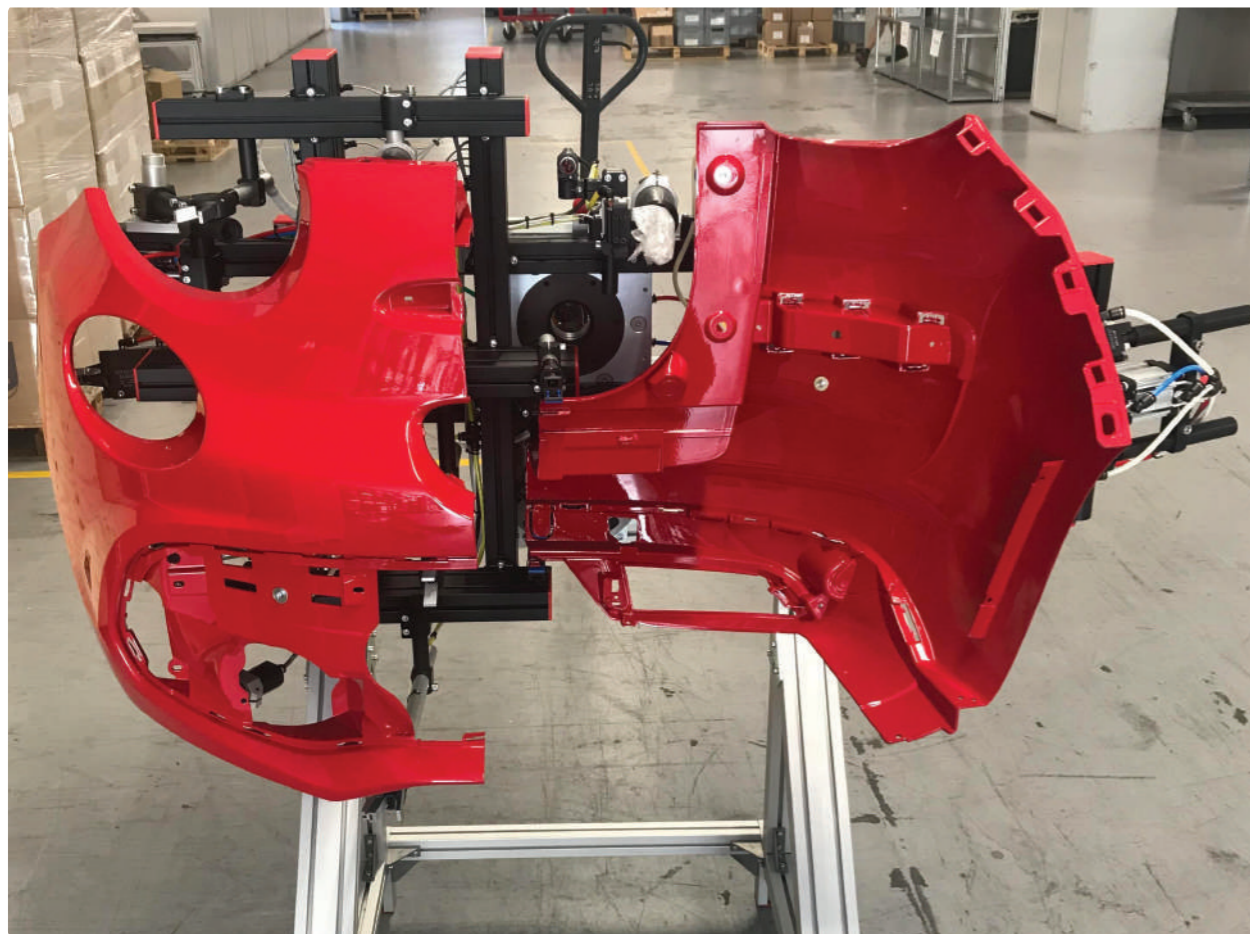

DISPLAY-50

Robot Display

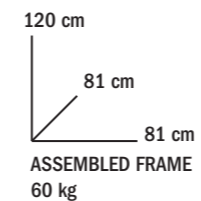

Free for exhibition

FULL DISPLAY
€ 2000,00 (in case of buying)

DISPLAY without actuators and cables
€ 1000,00 (in case of buying)

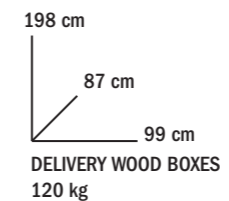

Phytosanitary treatment is not necessary due to the plywood material (ISPM-15)

Power supply	220 Vac
Air Connection	pipe Ø8

Robot not Included

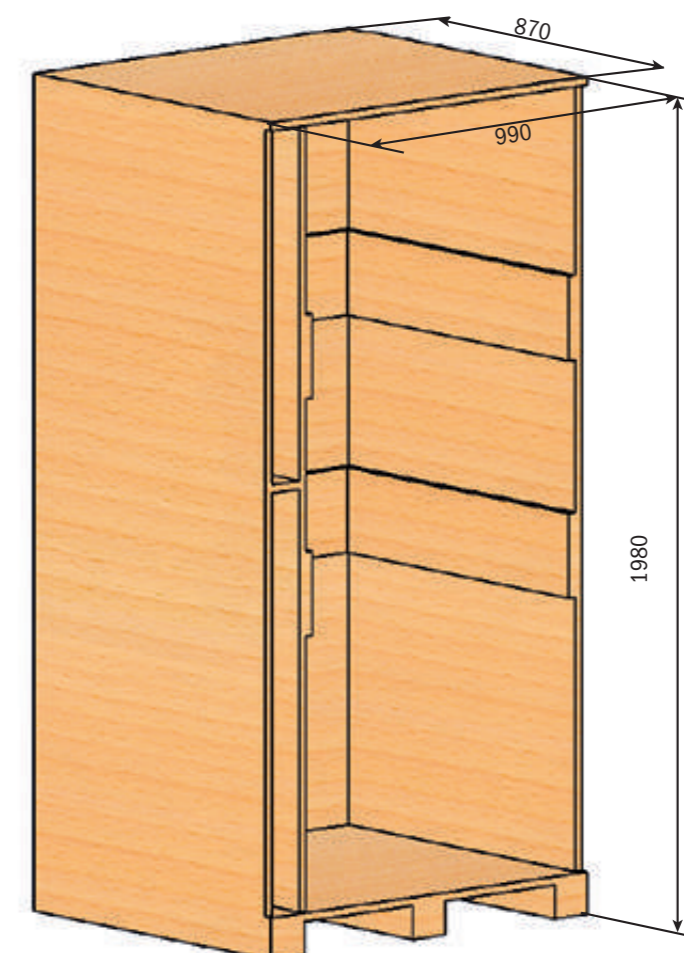

DISPLAY-50

Mounting parts

Robot not Included



DISPLAY-51

E0AT demo display

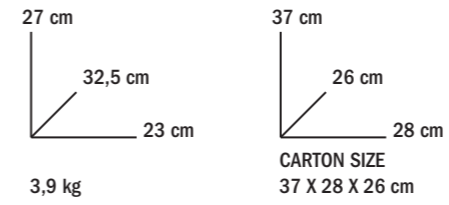

Free for exhibition

FULL DISPLAY
€ 1000,00 (in case of buying)



MFI-A11	4
MFI-A204	4
VSNF2050-NC	4
VAB18M18F-NO	4
MFI-A379	3
MFI-A239	4
SS3N203-G	4
MBQC	1
RBQC	1
SBMK	1
SBMM	1
SBMS	4
QC90-A	1
RAQCN	1
MAQC	1
VS.PFG50HT160N008	4
AVS.N008G18AG240	4

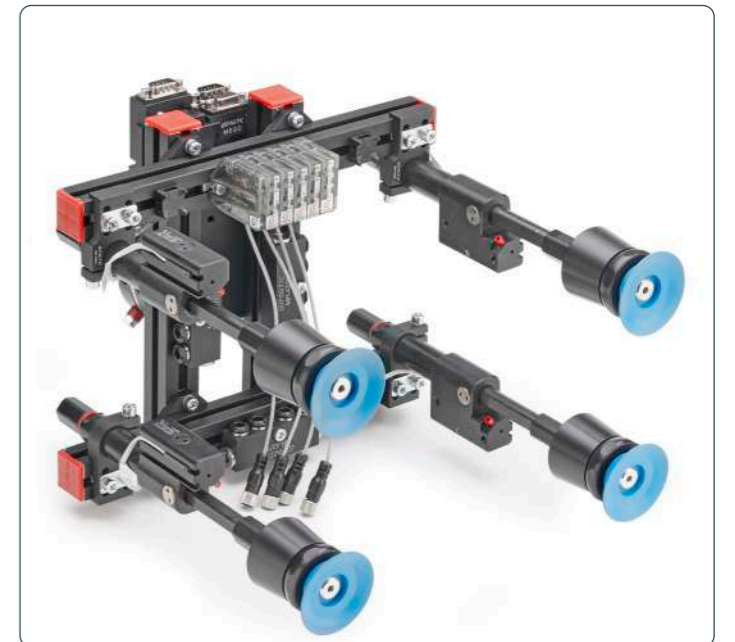

DISPLAY-52

Vacuum Display

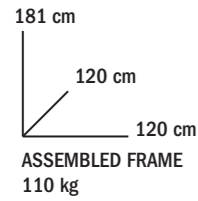

Free for exhibition

FULL DISPLAY
€ 5000,00 (in case of buying)

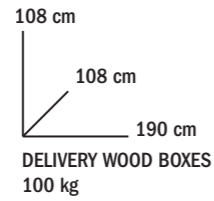

Phytosanitary treatment is not necessary due to the plywood material (ISPM-15)

Power supply	220 Vac
Air Connection	pipe Ø8

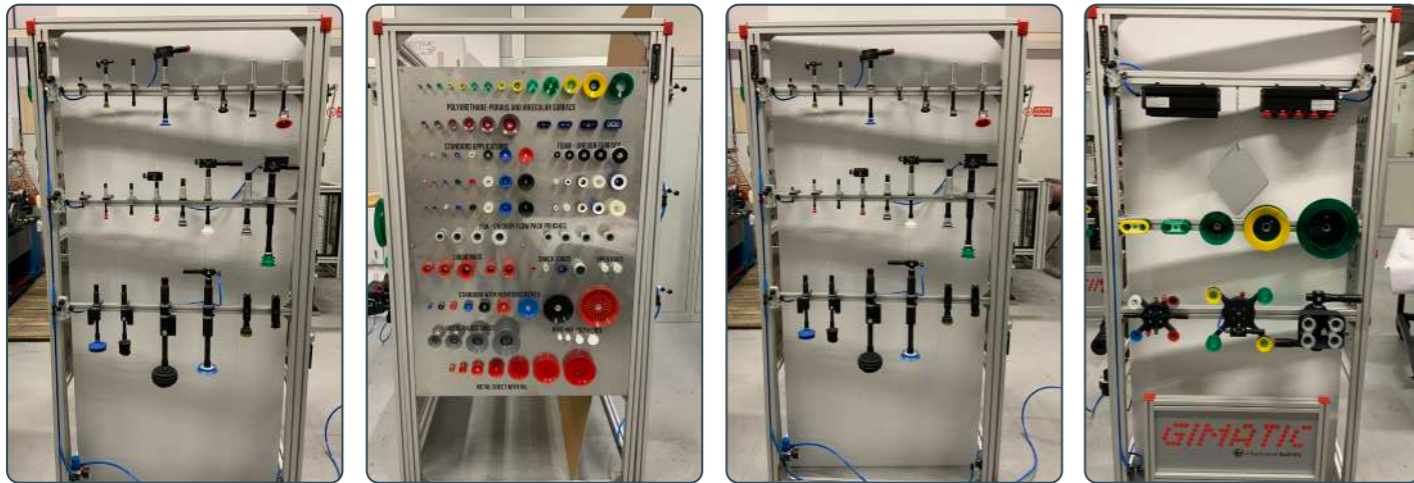
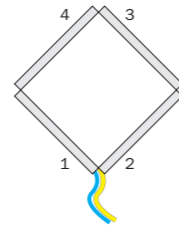

PAN-ESP-VACUUM-1

0000001	1	2321403	1	2321829	1	2322100	1	2322202	1
0000003	1	2321427	1	2321857	1	2322102	1	2322215	1
0000005	1	2321464	1	2321862	1	2322106	1	2322217	1
0000006	1	2321481	1	2321899	1	2322112	1	2510018	1
0000007	1	2321502	1	2321906	1	2322113	1	3100040	1
0221754	1	2321523	1	2321914	1	2322119	1	3100046	1
0221777	1	2321538	1	2321915	1	2322120	1	3100050	1
0321549	1	2321554	1	2321916	1	2322121	1	3100054	1
0321568	1	2321559	1	2321917	1	2322123	1	3511018	1
0321609	1	2321561	1	2321920	1	2322125	1	3520018	1
0321616	1	2321568	2	2321935	1	2322131	1	5210014	1
0321652	1	2321575	1	2321951	1	2322136	1	5221014	1
0321857	1	2321587	1	2321966	1	2322142	1	7511038	1
0321878	1	2321594	1	2321972	1	2322143	1	7520038	1
0321899	1	2321638	1	2321988	1	2322145	1	DISPLAY-52-01	1
1011005	1	2321645	1	2322002	1	2322151	1	MFI-025	9
1020005	1	2321653	1	2322010	1	2322154	1	MFI-038	4
1322143	1	2321694	1	2322024	1	2322157	1	MFI-040	2
1322145	1	2321711	1	2322040	1	2322159	1	MFI-177	2
1322147	1	2321742	1	2322072	1	2322161	1	MFI-A140	12
1510005	1	2321755	1	2322083	1	2322163	1	MFI-A141	4
1521005	1	2321756	1	2322085	1	2322165	1		
2011016	1	2321763	1	2322089	1	2322170	1		
2020018	1	2321825	1	2322095	1	2322174	1		

PAN-ESP-VACUUM-2

2321965	1	DISPLAY-52-09	2	MFI-A206	1	RG.5511600013-01	3
2322050	1	DISPLAY-52-10	2	MFI-A239	5	RG.5511600014-01	2
2322177	1	DISPLAY-52-11	2	MFI-A46	1	RG.5511600017-01	2
2322191	1	DISPLAY-52-12	1	RG.020900001AANT-01	1	RG.5523000004-01	1
3330080	1	EJ-MLG-D5	8	RG.0301500001-01	2	RG.5531000002-01	1
9900038	1	MFI-025	1	RG.05020000102NB-01	2	SS3N203-G	1
9900042	1	MFI-038	7	RG.0702000002-01	4	2322228	1
DISPLAY-52-02	1	MFI-040	2	RG.50-020-00N01-01	1	3100062	1
DISPLAY-52-05	4	MFI-055	1	RG.5002000N04-01	1	3100056	1
DISPLAY-52-06	2	MFI-177	3	RG.5504000010-01	1		
DISPLAY-52-07	2	MFI-A140	14	RG.5511600002-01	1		
DISPLAY-52-08	2	MFI-A141	4	RG.5511600004-01	1		

PAN-ESP-VACUUM-3

107-G1-8	3	3300019	1	3330095	1	DISPLAY-52-14	1	MFI-038	4
107-M5	1	3300023	1	3330104	1	DISPLAY-52-15	1	MFI-040	2
3030119	2	3300027	1	3330111	1	DISPLAY-52-16	1	MFI-043	1
3030150	1	3300033	1	3330116	1	DISPLAY-52-19	1	MFI-050	10
3030157	1	3300037	1	3330119	1	EJ-BBT10-03	1	MFI-055	5
3030219	1	3300041	1	3330120	1	EJ-BBT20-03	1	MFI-148	4
3030227	1	3300045	1	3330123	2	EJ-BBT30-03	1	MFI-177	12
3030241	1	3300049	1	3330127	2	EJ-BBT40-03	1	MFI-A140	36
3100028	1	3300053	1	3330130	1	EJ-LINE-AQR-C4	2	MFI-A141	4
3100029	1	3330059	1	3330131	1	EJ-SYS-D4	3	MFI-A251	1
3300001	1	3330065	1	3330132	1	EJ-SYS-N3	3	MFI-A46	2
3300003	1	3330075	1	3330133	1	MFI-009	3	MFM-A106	1
3300005	1	3330076	1	3330134	1	MFI-016	3	RG.0209200002-01	1
3300007	1	3330078	1	3330147	1	MFI-020	1	RG.0301500002-01	3
3300011	1	3330081	1	3400101	1	MFI-025	4	RG.5002000N05-01	2
3300015	1	3330091	1	DISPLAY-52-13	1	MFI-027	1	RG.5511600017-01	2

PAN-ESP-VACUUM-4

1102138	1	DISPLAY-52-22	1
1501112	1	DISPLAY-52-23	2
2002112	1	MFI-025	21
2322222	1	MFI-038	6
2322223	1	MFI-040	2
2330115	1	MFI-177	3
353010202	1	MFI-A140	12
353350202	1	MFI-A141	4
DISPLAY-52-05	4	MFI-A239	3
DISPLAY-52-06	2	MFI-A46	1
DISPLAY-52-07	2	PSA1313	1
DISPLAY-52-08	2	PSA1818	1
DISPLAY-52-09	2	RG.0301500001-01	3
DISPLAY-52-10	2	RG.0301500002-01	1
DISPLAY-52-11	1	RG.0702000002-01	1
DISPLAY-52-12	1	RG.5511600017-01	4
DISPLAY-52-20	1	RG.5511600018-01	2
DISPLAY-52-21	1		

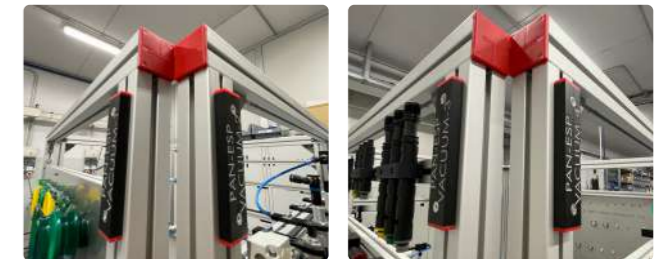

Combine 1-2-3-4 frames as picture



Fix frames with 4 brackets on the top and 4 brackets on the top



Connect Air connection pipes

DISPLAY-53

Demo display Vacuum

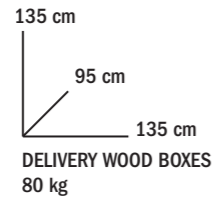
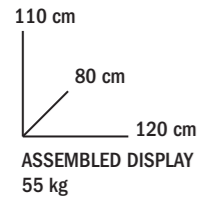

Phytosanitary treatment is not necessary due to the plywood material (ISPM-15)



DELIVERY WOOD BOXES + ASSEMBLED DISPLAY: 135 kg

Free for exhibition

FULL DISPLAY
€ 5000,00 (in case of buying)



This display has a tub that holds various vacuum items for hands-on demonstrations at the fair.

This display has two manually operated valves and blisters containing objects of various materials (wood / polycarbonate / cardboard / flock).

In addition, the receiving distributors will have to procure items for practical tests each time (chips / biscuits / etc. etc.).



7	1
8	1
221754	1
221761	1
221777	1
321553	1
1011000	2
1011005	2
1020005	1
1021005	2
1322145	1
1322147	1
1501112	1
1510000	1
1510005	1
1511005	1
1520005	1
1521005	1
2001112	1
2010006	1
2011018	1
2321542	2
2321544	2
2321547	2
2321711	2
2321712	2
2321905	1
2321913	1
2321926	1
2321930	1
2321952	2
2321987	1
2322031	1
2322052	1
2322053	1
2322054	1
2322055	1

2322061	1
2322062	1
2322072	1
2322082	1
2322102	1
2322109	1
2322119	1
2322120	1
2322121	1
2322123	1
2322125	2
2322131	1
2322132	1
2322136	1
2322137	1
2322143	2
2322145	2
2322151	1
2322154	1
2322157	1
2322165	1
2322168	1
2322174	1
2322175	1
2322176	1
2322192	2
2322212	2
2322214	1
2322215	1
2322217	1
2322223	1
2511018	1
2521006	1
3030125	1
3030132	1
3030223	1
3100040	1

3100055	1
3300016	1
3300057	1
3330061	1
3330062	1
3330064	1
3330065	1
3330066	1
3330078	1
3330088	1
3330118	1
3330131	1
3330136	1
3331073	1
3331075	1
3331115	1
3510018	1
3510019	1
3510038	1
3511038	1
3520000	1
3520014	1
3521014	2
3521018	1
5211038	1
5220000	1
5220038	1
7510000	1
7510038	1
7511038	1
2322142	2
STICKER-56	2
DISPLAY-COVER	1
RG.5002000N05	1
RG.5002000N06	1
RG.5002000N07	1
RG.5002000N08	1

RG.5002000N09	1
RG.5002000N31	1
RG.0203000010WNB	1
RG.020300001ATNB	1
RG.020500001ATNB	1
RG.030000001B5NB	1
RG.020100001B5NB	1
RG.02010000102NB	1
RG.0209000010WNT	1
RG.0301500001	1
DISPLAY-53-03	2
DISPLAY-53-04	1

TOOL BOX

30 cm
30 cm
60 cm
10 kg

Free for exhibition



Fuse 10.3 X 38 500 Vac 2 A	10
Fuse 10.3 X 38 500 Vac 4 A	10
Fuse 10.3 X 38 500 Vac 6 A	10
Air Distributor (MFI-A67)	1
Manual Valve (FEM - FEM 3/8)	1
Digital Multimeter	1
Meter (5 m)	1
Nylon cable ties black 200x2.5mm	100
Insulating tape 25m 15x0.15 mm Black	1
3-pin power strip	1
Extension (220 V)	1
Screwdrivers	5
Wrenches (6-22)	8
Hex Key Sets	1
Rubber mallet with wooden handle	1
Hammer	1
Scissors	1
Tongs	1
Cutter	1
Pipe wrench	1
Pack of Feltre	1

Teflon	1
Biadhese	1
Scotch tape	1
Paper tape	1
Paper Roll Hands	1
Degreasing	1
Reduction (MAL - MAL 3/8 - 1/4)	1
Reduction (MAL - MAL 1/2 - 3/8)	1
Reduction (MAL - FEM 1/2 - 3/8)	1
Elbows swing (ø 1/4 Tube 8)	2
Elbows swing (ø 3/8 Tube 8)	1
Straight coupling (ø 1/4 Tube 8)	1
Plug 1/4	1
Nipple 1/2	1
Straight male adaptor (ø 1/8 Tube 8)	2
Swiveling elbow male adaptor (ø 1/8 Tube 8)	2
Reducer (ø 1/8 - 1/4)	2
Welder tin	1
Tin roll	1
T connector (ø 8)	10

START-CASE

8 cm
32 cm
45 cm
10 kg

Free for exhibition
€ 249,60 (in case of buying)



AV0118M13	4
AV0118M16	4
EMF-2525-0250	2
EMF-2525-0400	2
MFI-A06	4
MFI-A11	4

MFI-A145	4
MFI-A21	1
MFI-A37	4
MFI-A43	1
MFI-A49	4
MFI-A68	1

MFI-A71	4
V0211S01	4
V0233S01	4
VALIGIA-ARTPLAST	1

SB2T

45 cm
24.5 cm
57.5 cm
1.5 kg

Free for exhibition
€ 286,00 (in case of buying)

SS4N225-G	2
POWER SUPPLY	1
SG3A2-G	1
SG3N2-G	1
CFGM800325	1
BATTERY	1



VACUUM-CASE

VACUUM-CASE
€1.200,00

38 cm
23 cm
54 cm
13 kg



VACUUM-BLISTER-01

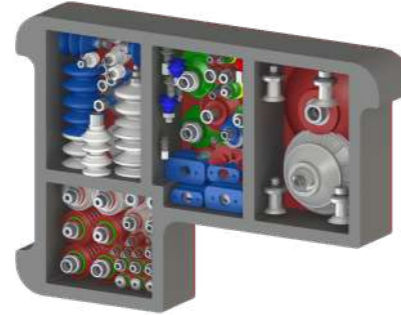

VACUUM-BLISTER-02



VACUUM-BLISTER-01

3330132	1	3330061	1	3330094	1	3330082	1
3330131	1	3330075	1	VSNTF2050-NO	1	3330115	1
VAB18M18F-NO	1	3330057	1	3300042	1	3330106	2
VAQN1820	1	3030132	1	3300046	1	3300008	2
VSRT1025	1	3030139	1	3300050	1	3300002	2
VSRT1010	1	3330088	1	3300012	2		
3100028	1	3330086	1	3030152	1		
3100029	1	3330119	1	3030120	1		
3030125	2	3330130	1	3330072	1		

VACUUM-BLISTER-02

0000001	1	2321580	2	2322029	1	2322143	2
0000005	1	2321592	2	2322029	1	2322145	2
0000007	1	2321593	2	2322045	1	2322153	1
0000009	1	2321605	2	2322053	4	2322156	1
0000011	1	2321609	2	2322055	4	2322157	1
0000013	1	2321694	1	2322066	2	2322164	1
0321545	2	2321700	2	2322067	2	2322165	2
0321552	2	2321715	2	2322070	4	2322170	2
0321560	2	2321731	2	2322072	4	2510016	2
0321575	2	2321733	2	2322075	2	2511018	2
1010005	2	2321747	2	2322077	2	3100042	1
1011005	2	2321756	4	2322083	2	3100050	1
1020005	2	2321825	2	2322119	2	3100055	1
1510005	2	2321846	2	2322120	2	3510018	2
1511005	2	2321856	2	2322121	2	3511038	2
2010016	2	2321899	2	2322122	2	5210038	2
2021016	2	2321906	2	2322123	2	5221038	2
2321403	2	2321909	2	2322124	2	7521038	1
2321495	2	2321917	1	2322131	2		
2321500	2	2321952	3	2322136	2		
2321519	2	2321988	1	2322142	2		

HANDLING-MECHA-CASE

HANDLING-MECHA-CASE
Complete demo-case with blisters and products
(handling and mechatronics).

€ 3.000,00
*Empty case is available, 250 €

38 cm
23 cm
54 cm
16 kg



* - VAL: demo sample without internal moving parts



HANDLING-BLISTER
Blister with Handling products.

€ 1.200,00
Empty blister KIT-BLISTER-71-73, 20 €

32,5 cm
6,4 cm
47 cm
5 kg

* - VAL: demo sample without internal moving parts



MECHA-BLISTER
Blister with Mechatronics products.

€ 1.300,00
Empty blister KIT-BLISTER-72-74, 20 €

32,5 cm
7,5 cm
45 cm
5 kg

* - VAL: demo sample without internal moving parts

DH2208	1	SS3N203-G	1
TH5404	1	SL3N203-G	1
PQ3015	1	SN3N203-G	1
MGX3210	1	RTD-10	1
SGP-25S	1	CB3N2-G	1
SX4020	1	IFU05S01RT	1
PT25	1	ZE1010P	1
GW-10	1	XP-20	1
TFA14-25	1	PE-1640	1
MFU33E02CL	1	GM-0025	1
Z-0825	1	SZ16	1
GX-16S	1	GS-16	1
MFC33	1	ZA0830	1
RT-10	1	ALLENKEY	1

MPPM1606-VAL	1	EQC20-A	1
MPTM1606-VAL	1	EQC20-B	1
MRE16180-VAL	1	CHT10	1
MPRM1690-VAL	1	MPRJ2553	1
MPBM1640-VAL	1	MPLF1630-VAL	1
MPS24-1-S-PNP	1		
ML4070X4-VAL	1		
ML20X10L238-VAL	1		
MPXM1612-VAL	1		
MTRE3204-VAL	1		
SS3N203-G	1		
MPBS1630X-VAL	1		
CFGM2200700	1		

PLASTICS-CASE

BLISTER 01



PLASTICS-CASE

€2.000,00

* Empty case is available, 250 €

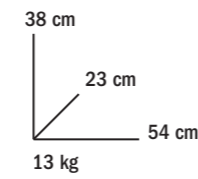

13 kg

PLASTICS-BLISTER-01

€ 300,00

2,6 Kg

47,5 x 32,5 x 4,2 cm

Empty blister KIT-BLISTER-51-73, 20 €

PLASTICS-BLISTER-02

€ 650,00

2,4 Kg

47 x 32,5 x 4,2 cm

Empty blister KIT-BLISTER-52-73, 20 €

PLASTICS-BLISTER-03

€ 400,00

4,3 Kg

45 x 32,5 x 4,4 cm

Empty blister KIT-BLISTER-53-74, 20 €



BLISTER 02



BLISTER 03

BLISTER 01

MFI-A329	2	MFI-A353	1	SBMK	1	PMAQC	1
MFI-235	4	QCY90-A	1	RAQC	1	PMBQC	1
MFI-A41	1	QC90-B	1	KIT-ESTRUSI	1	MFI-A372	1
MFI-A141	1	QC90-013	1	QCP50-B	1	VITE-496	6
MFI-A140	1	QC9065	1	SI4N225-G	1	QC50-K	1
PT23N	2	CAQC	1	RBQC	1	QCY50-A	1
MFI-A11	1	CBQC	1	SBMM	1	SS3N203-G	1
MFI-A16	1	SBMS	1	SQC100-A	1	MFI-A356	1

BLISTER 02

VSE2050F18	1	AA-35	1	MFI-A260	1	MFI-A364	1
PAAT16R-01	1	SGP-25S	1	VSE1420F18	1	2321618	1
SZ12	1	MFI-A98	1	PT28	1	9900019	1
PQ1608	1	OFA20-35	1	VVX1420F	1	2321606	1
OFL2010	1	OFR20-95G	1	VSS2025	1	2011000	1
AF10G18M	1	DC20-16C	1	VSR1010	1	3510014	1
BB-12-NO	1	OFX20-10	1	VAM18M18G	1		
GS-10	1	OFD20	1	VSNG1420	1		
GW-10	1	VMK14	1	OFFP14A-25	1		

BLISTER 03

SOQ8N2-G	1	MFI-A02	1	MFI-A66	1	MFU27S01CL	1
AGG19-B	1	MFI-A03	1	MFI-A39	1	GN-05S	1
AGG21-C	1	MFI-A252	1	MFP-A02	1	G.N5AP	1
MFI-A332	1	MFI-A117	1	MFI-A38	1	MFM-A30	2
MFC22	1	MFI-A106	1	MFI-A78	1	ZG-16S-NO	1
MFD22E02CL	1	MFI-A53	1	MFI-A64	1	ZL160	1
GNS-05-NO	1	MFI-A55	1	MFI-A34	1		
MFI-A310	1	MFI-A46	1	MFI-A10	1		
SU9N2-G	1	MFI-A68	1	IFU05S01RT	1		

CONTACT DOCUMENT

Ask excel version to Gimatic



Messebericht / Fair



vom/date:

Bitte Visitenkarte anheften/ Please pin BC

Bitte schön schreiben!/ Please write clearly!

Oder deutlich schreiben + komplette Adresse angeben!/ Please fix here the BC or write clearly the address

Name/Name

Firma/ Company

Position

Straße/ Address

PLZ/ Cap

Land/ Country

Tel.

Fax

E-Mail

Webseite/Website

Messtag / Fair day

1 07.05	2 08.05	3 09.05
------------	------------	------------

Interesse: bitte ankreuzen/make a x

- Handling
- Greifer/grippers
- Plastic
- Sensoren/sensor
- Mecha
- Kundenspez/customized

- Linearmotoren
- Carbon
- Sonstiges/Others
- Systeme

Bearbeiter /

Who collect the info

Eingegeben in CRM/

enter in CRM

ProdSpez/

Product Specialist

1 Level – Kategorie (deutsch/english)

- Direktkunde / Direct
- Divers / Various
- Endverbraucher / End User

- Händler / Distributor
- kundenspez. Produkte / Private Label
- OEM Hersteller / OEM Manufacturer

Wettbewerb / Competitor

2 Level – Branche (deutsch/english)

- Montage Autom. allg. / Assembly autom. Equip.
- Blechverarb. Maschinen / Sheet Metal M. Prod.
- Chem. Maschinen / Chemical Machines
- Diverse / Others
- Elektr. Geräte / Electrical Devices
- Elektr. Systeme / Electrical Systems
- Formenbauer / Mould Manufacturer

Holzmaschinen / Wood Machines

Konstruktionsbüro / Engineering Office

Konstruktionsb.Plastic / Engin. Plastic

Kunststoffspr. / Plastics Inject

Maschinenbau WZM / Tools Machines

Mechan. Betrieb / Mechanical Workshop

Medical/Pharma / Medica /Pharma Mach.

Produktionsausst. / Prod.

Rob. Herst. Anw. / Rob. U.

Schuhmasch. / Shoes

Sonderm. / Special Machines

Verpackungsma. / Pack. Mach.

Zuführ. Handling / Handling-

Feeding or Handling-Conveyor

3 Level - Segmente (deutsch/english)

- Agrartechnik / Agriculture
- Automotive / Automotive
- Blechverarbeitung / Sheeting
- Chemische Industrie / Chemical
- Elektrische Apparate / Electrical Devices
- Elektrische Systeme / Electrical Systems
- Elektrogeräte / Electrics
- Filter Systeme / Filtration Systems
- Glasverarbeitung / Glasses
- Gummi Herstellung / Rubber Moulding

Haustechnologie/Building Technology

Hygiene / Hygiene

Inmold Labeling / IMM

Kosmetik & Haushalt / Beauty & Home

Labor Automation / Lab Automation

Medical / Medical

Nahrungsm. & Getr. / Food & Bever.

Pharma / Pharma

Polymer Processing / Polymer Proc.

Reinraum / Clean Room

Roboter / Robotics

Rohr Systeme / Pyping Sys.

Sicherh. Sys. / Security Sys.

Sonstiges / Others

Spielwaren / Toys

Sprizgußformen / Moulding

Textil / Textile

Vakuum / Vacuum

Verpackung / Packaging

Weißware / Home App.

Potential: null/no gering/low mittel/medium hoch/high

EXHIBITION REPORT

Ask excel version to Gimatic

EXHIBITION

Name	
WebSite	
Date (dd/mm/yy)	
Days (n°)	
Country	
Type (Plastics; Handling; Mecha; Sensors)	
N° visitors (Previous Edition)	
N° expositors (Previous Edition)	
Hold by	
Note	

CONTACTS

N° of contacts all exhibition	
N° of contacts per day	
N° of new contacts	
Nationality	
Type of customer (Direct, EndUser, Distributors, ...)	
Main segments	
Main interest (Plastics, Handling, Mecha, Sensors)	
Sales and technical main request	
Main competitors	
Note	

COSTS

€/space	
€/stand	
€/delivery	
€/fees	
€/people	
€/services	
€/exhibition advertising	
€/Total costs	
Note	

EXHIBITION REPORT

BOOTH

Construction manufacturer	
Square meters booth	
Positioning	
Dimension	
Facilities	
Lighting	
General layout	
Note	

DEMO MATERIAL

Catalogue	
Brochure	
Demo static display (DISPLAY-...)	
Demo dynamic display (DISPLAY-...)	
Demo static display (PAN-...)	
Gimatic bags	
Gimatic pens	
USB	
CD-ROM	
Others...	
Note	

NEXT YEAR EXHIBITION

Name	
Note	
Write by	
Date	
Final Note	

PAPER MARKETING

COVER STORY
(Examples)



INTERNAL ADVERTISE
(Examples)



CASE HISTORY
(Examples)

EDITORIAL
(Examples)



PAPER MARKETING CHECK LIST

Our goal is to define the best successful points for succesful advertaising campaign:

- Have you defined best techical magaziene for our Market in your area?
- Have you found any of our competitors on these magazines?
- Have you checked how many copies they print?
- Have you checked how many release they do during a year?
- Have you checked if their publishing house provide different trade magazines?
- Have you get best offer for your advertaising campain?
- Have you defined best Month to make advertaise (better previous or the same as exhibition)?
- Have you asked Gimatic to provide you advertaise template (cover, internal magazine, ...)?
- Have you asked Gimatic to provide you editorial about our newest products?
- Have you asked or shared with Gimatic succesful case history?

PAPER MARKETING PLAN

Ask excel version to Gimatic



ADVERTISING PLAN (rev.2015-01)	
PAPER MARKETING	
Trade Magazine	
Publishing house	
Type of magazine (H;P;M;S)	
n°copies	
Yearly release	
Competitors on this Trade magazine	
GIMATIC PAPER RELEASE	
Month release	
Type of release (cover, editorial, internal adv..)	
Subject of release (ask Gimatic material)	
Main Language of release	
Free option web release (case history, editorial..)	
€/release	
€/people (external adv. service)	
€/Total costs	
€/TOTAL ADVERTAISING COSTS	
DATE	
WRITTEN BY	
NOTE	

WEB MARKETING

SOCIAL



These are our current social networks:

- Facebook
- LinkedIn
- Twitter
- Instagram
- Youtube

Follow us on social networks and share the latest news.

PORTALS



A portal that shows our products and where the customers can make they requests.

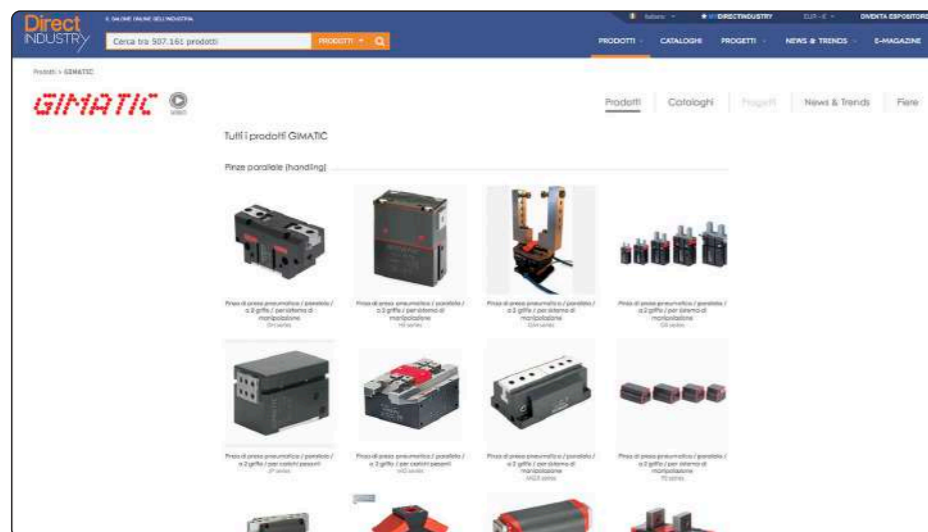

WEB MARKETING CHECK LIST

Our goal is to define the best succesful points for succesful advertaising campaign:

- Have you defined best techical web portal for our Market in your area?
- Have you found any of our competitors on these web portal?
- Have you get best offer for your banner advertaising campain?
- Have you defined best Month to make banner advertaise (around as exhibition)?
- Have you checked if they provide mailing?
- How many contact leads they can reach by e-mail?
- Have you asked Gimatic to provide you Banner advertaise template?
- Have you asked Gimatic to provide you editorial about our newest products?
- Have you asked or shared with Gimatic succesful case history?

WEB MARKETING PLAN

Ask excel version to Gimatic

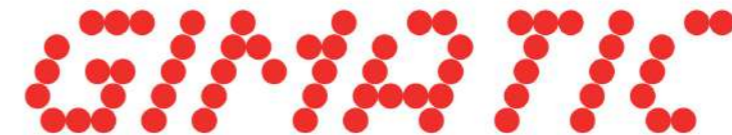

A business of BARNES GROUP INC

ADVERTAISING PLAN (rev.2014-12)	
WEB MARKETING	
Web Portal	
Website	
Type of web portal (H;P;M;S)	
Ranking	
Yearly release	
Competitors on this Web Portal	
GIMATIC WEB RELEASE	
Month release	
Type of release (banner, editorial, web shop..)	
Subject of release (ask Gimatic material)	
Main Language of release	
Free option web release (case history, editorial..)	
€/web release	
€/people (external adv. service)	
€/Total costs	
€/TOTAL ADVERTAISING COSTS	
DATE	
WRITTEN BY	
NOTE	



GIMATIC™
A business of BARNES

Via Enzo Ferrari, 2/4
25030 Roncadelle (BS) ITALY
tel. +39 030 2584655
fax +39 030 2583886
info@gimatic.com
www.gimatic.com